

V_{DSM}	=	6500 V
I_{TAVM}	=	760 A
I_{TRMS}	=	1200 A
I_{TSM}	=	11600 A
V_{T0}	=	1.22 V
r_T	=	0.970 mW

Phase Control Thyristor

5STP 08G6500

Doc. No. 5SYA1006-03 Aug.00

- Patented free-floating silicon technology
- Low on-state and switching losses
- Designed for traction, energy and industrial applications
- Optimum power handling capability
- Interdigitated amplifying gate.

Blocking

Part Number	5STP 08G6500	5STP 08G6200	5STP 08G5800	Conditions
V_{DSM} V_{RSM}	6500 V	6200 V	5800 V	$f = 5$ Hz, $t_p = 10$ ms
V_{DRM} V_{RRM}	5600 V	5300 V	4900 V	$f = 50$ Hz, $t_p = 10$ ms
V_{RSM1}	7000 V	6700 V	6300 V	$t_p = 5$ ms, single pulse
I_{DSM}	≤ 200 mA			V_{DSM}
I_{RSM}	≤ 200 mA			V_{RSM}
dV/dt_{crit}	2000 V/ μ s			@ Exp. to $0.67 \times V_{DRM}$
$T_j = 125^\circ\text{C}$				

V_{DRM}/V_{RRM} are equal to V_{DSM}/V_{RSM} values up to $T_j = 110^\circ\text{C}$

Mechanical data

F_M	Mounting force	nom.	22 kN
		min.	14 kN
		max.	24 kN
a	Acceleration		
	Device unclamped		50 m/s ²
	Device clamped		100 m/s ²
m	Weight		0.6 kg
D_S	Surface creepage distance		38 mm
D_a	Air strike distance		21 mm



ABB Semiconductors AG reserves the right to change specifications without notice.

ABB

On-state

I_{TAVM}	Max. average on-state current	760 A	Half sine wave, $T_C = 70^\circ\text{C}$	
I_{TRMS}	Max. RMS on-state current	1200 A		
I_{TSM}	Max. peak non-repetitive surge current	11600 A	$t_p = 10 \text{ ms}$	$T_j = 125^\circ\text{C}$ After surge: $V_D = V_R = 0\text{V}$
		12300 A	$t_p = 8.3 \text{ ms}$	
I^2t	Limiting load integral	673 kA^2s	$t_p = 10 \text{ ms}$	
		628 kA^2s	$t_p = 8.3 \text{ ms}$	
V_T	On-state voltage	2.25 V	$I_T = 1000 \text{ A}$	$T_j = 125^\circ\text{C}$
V_{TO}	Threshold voltage	1.22 V	$I_T = 600 - 1800 \text{ A}$	
r_T	Slope resistance	0.970 $\text{m}\Omega$		
I_H	Holding current	40-90 mA	$T_j = 25^\circ\text{C}$	
		15-60 mA	$T_j = 125^\circ\text{C}$	
I_L	Latching current	100-500 mA	$T_j = 25^\circ\text{C}$	
		50-200 mA	$T_j = 125^\circ\text{C}$	

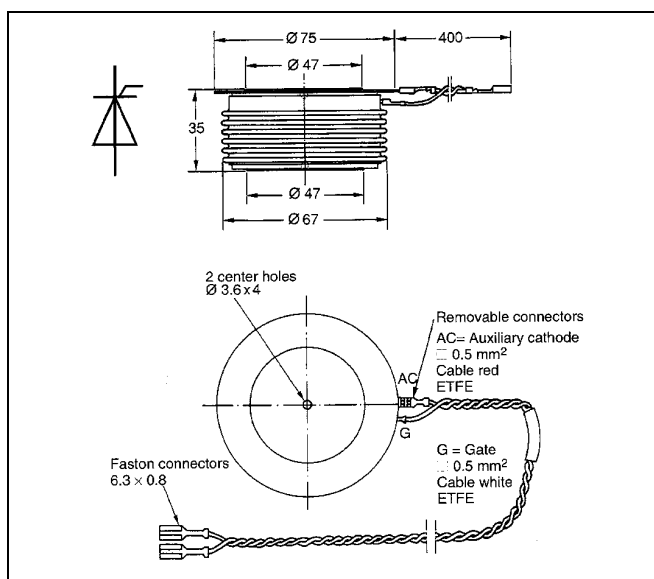
Switching

di/dt_{crit}	Critical rate of rise of on-state current	100 $\text{A}/\mu\text{s}$	Cont.	$V_D \leq 0.67 \cdot V_{DRM}$ $T_j = 125^\circ\text{C}$ $I_{TRM} = 2000 \text{ A}$ $f = 50 \text{ Hz}$ $I_{FG} = 2.0 \text{ A}$ $t_r = 0.5 \mu\text{s}$
		200 $\text{A}/\mu\text{s}$	60 sec.	
t_d	Delay time	$\leq 3.0 \mu\text{s}$	$V_D = 0.4 \cdot V_{DRM}$	$I_{FG} = 2.0 \text{ A}$ $t_r = 0.5 \mu\text{s}$
t_q	Turn-off time	$\leq 700 \mu\text{s}$	$V_D \leq 0.67 \cdot V_{DRM}$ $dv_D/dt = 20\text{V}/\mu\text{s}$	$I_{TRM} = 2000 \text{ A}$ $T_j = 125^\circ\text{C}$ $V_R > 200 \text{ V}$
Q_{rr}	Recovery charge	min	1600 μAs	$di_T/dt = -1 \text{ A}/\mu\text{s}$
		max	2700 μAs	

Triggering

V_{GT}	Gate trigger voltage	2.6 V	$T_j = 25^\circ\text{C}$
I_{GT}	Gate trigger current	400 mA	$T_j = 25^\circ\text{C}$
V_{GD}	Gate non-trigger voltage	0.3 V	$V_D = 0.4 \cdot V_{DRM}$
I_{GD}	Gate non-trigger current	10 mA	$V_D = 0.4 \cdot V_{DRM}$
V_{FGM}	Peak forward gate voltage	12 V	
I_{FGM}	Peak forward gate current	10 A	
V_{RGM}	Peak reverse gate voltage	10 V	
P_G	Maximum gate power loss	3 W	

Thermal

$T_{j\ max}$	Max. junction temperature	125°C	
$T_{j\ stg}$	Storage temperature range	-40...150°C	
R_{thJC}	Thermal resistance junction to case	43 K/kW	Anode side cooled
		45 K/kW	Cathode side cooled
		22 K/kW	Double side cooled
R_{thCH}	Thermal resistance case to heat sink	8 K/kW	Single side cooled
		4 K/kW	Double side cooled

Analytical function for transient thermal impedance:

$$Z_{thJC}(t) = \sum_{i=1}^n R_i(1 - e^{-t/\tau_i})$$

i	1	2	3	4
R_i (K/kW)	13.62	5.23	1.52	1.46
τ_i (s)	0.6894	0.0824	0.017	0.0077

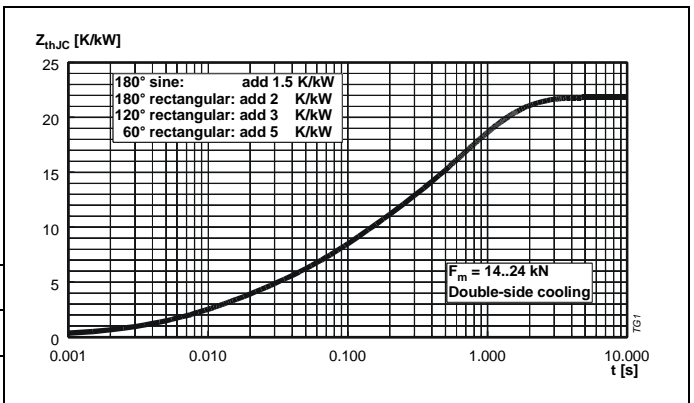

Fig. 1 Transient thermal impedance junction to case.

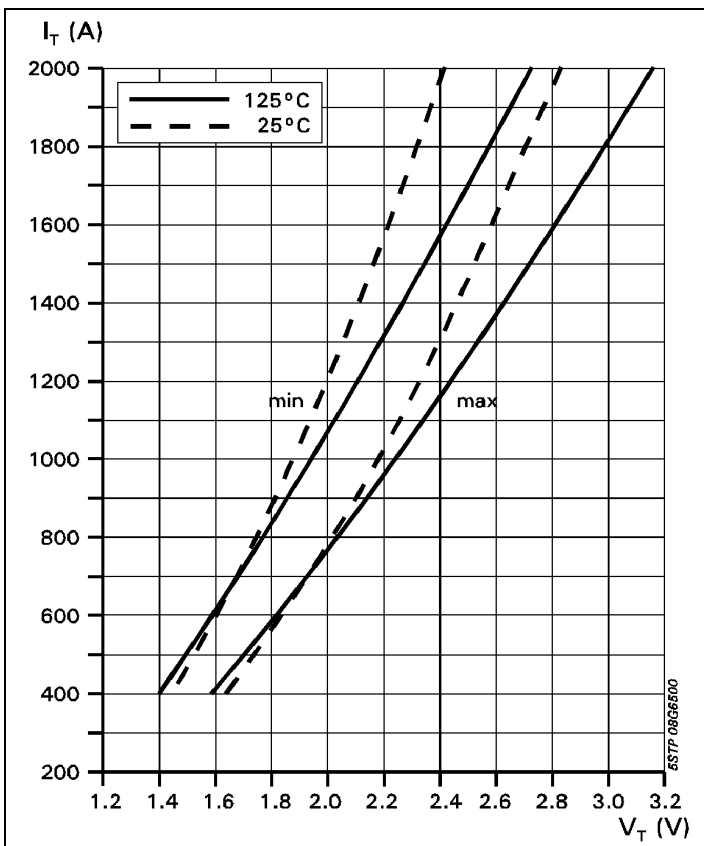

Fig 2. On-state characteristics.

On-state characteristic model:

$$V_T = A + B \cdot i_T + C \cdot \ln(i_T + 1) + D \cdot \sqrt{i_T}$$

Valid for $i_T = 400 - 3000$ A

A	B	C	D
-2.676495	0.00153	0.922004	-0.09435

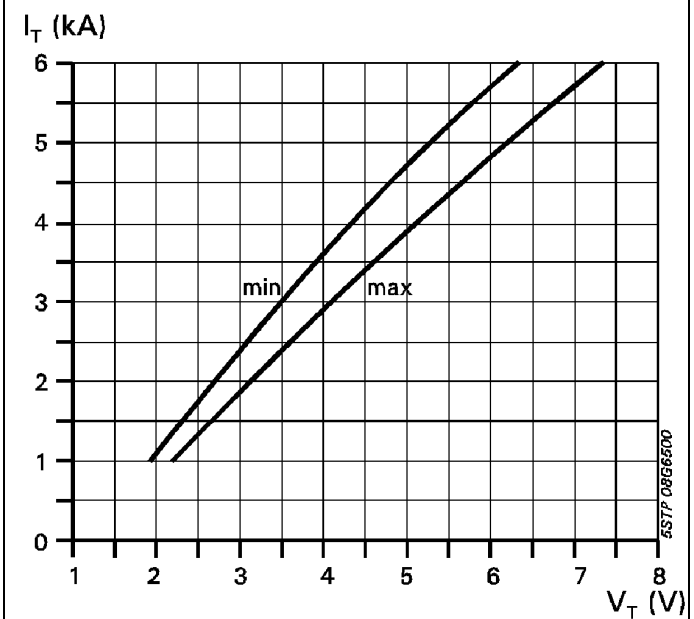

Fig. 3 On state characteristics.

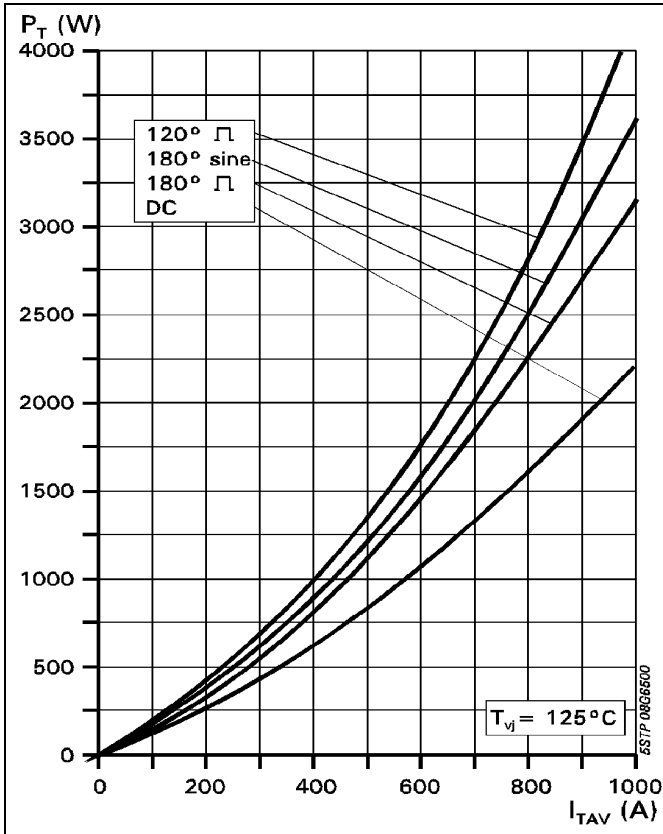

Fig. 4 On-state power dissipation vs. mean on-state current. Turn-on losses excluded.

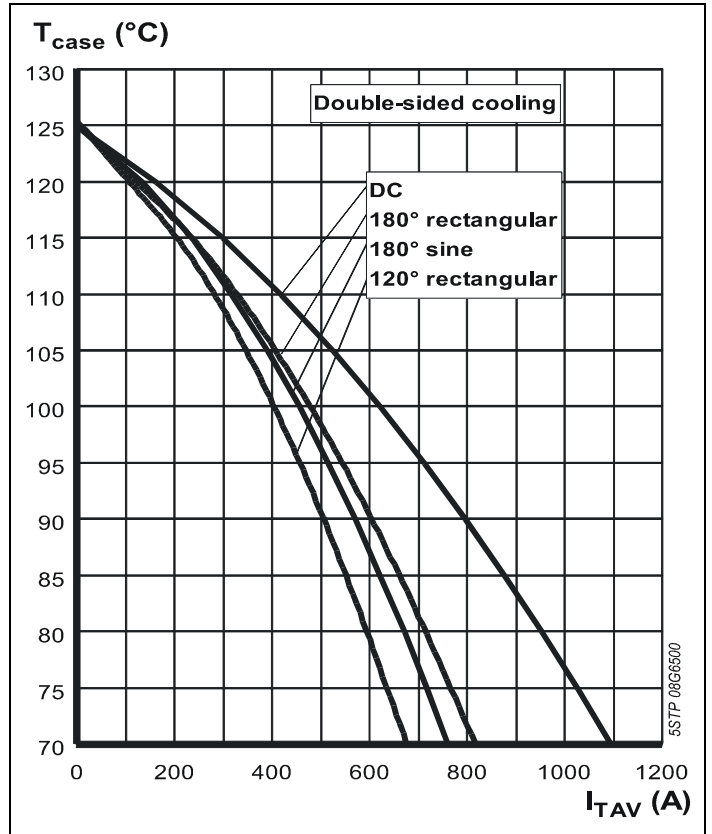

Fig. 5 Max. permissible case temperature vs. mean on-state current.

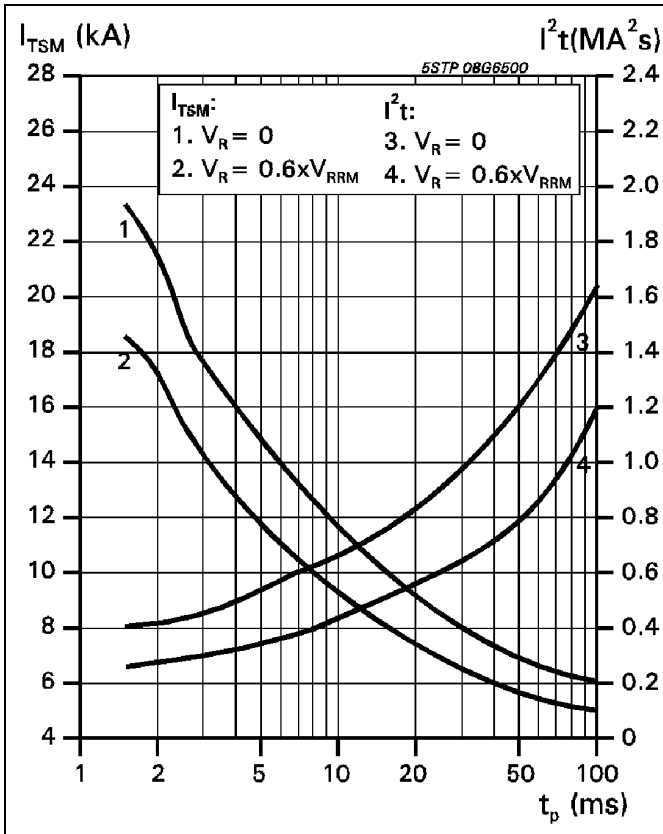

Fig. 6 Surge on-state current vs. pulse length. Half-sine wave.

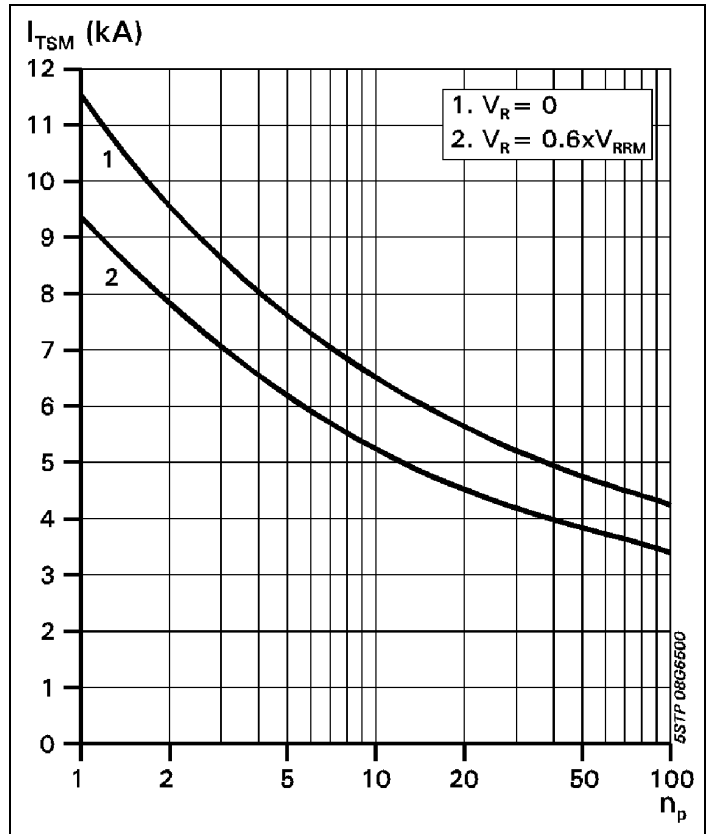

Fig. 7 Surge on-state current vs. number of pulses. Half-sine wave, 10 ms, 50Hz.

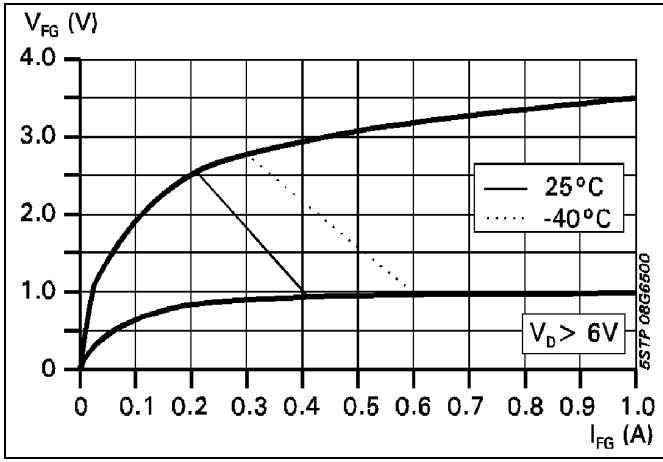

Fig. 8 Gate trigger characteristics.

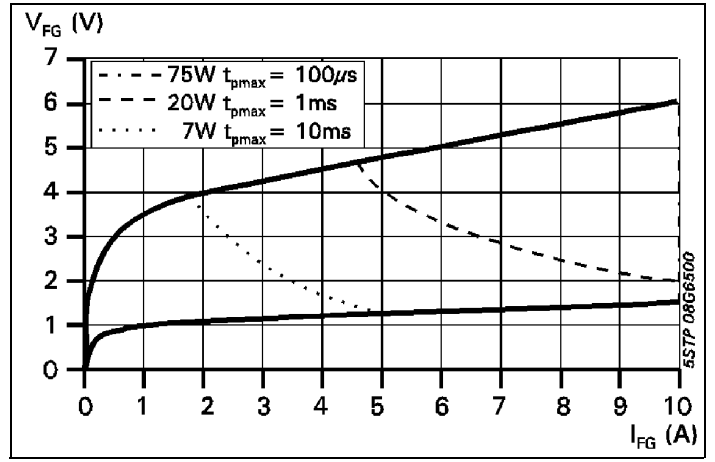

Fig. 9 Max. peak gate power loss.

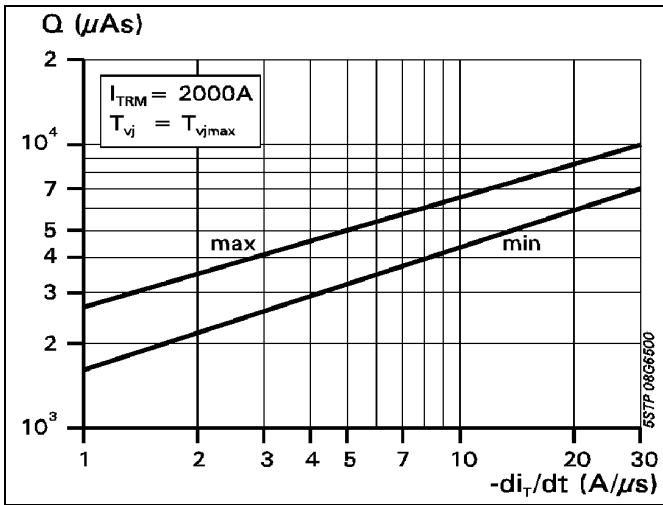

Fig. 10 Recovery charge vs. decay rate of on-state current.

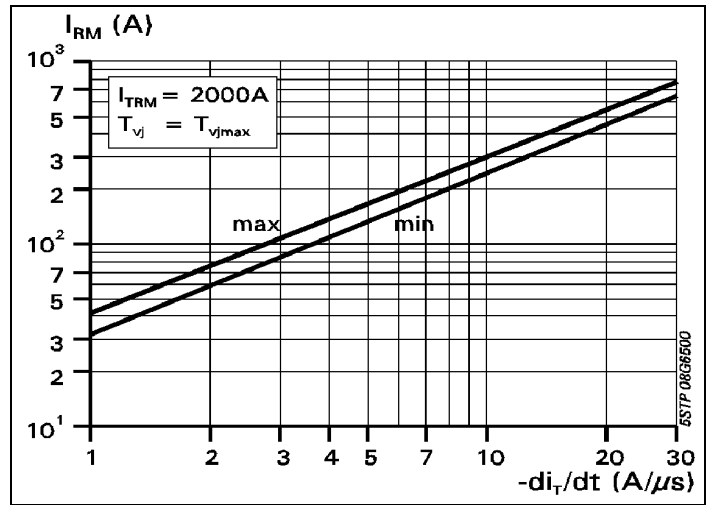

Fig. 11 Peak reverse recovery current vs. decay rate of on-state current.

Turn –off time, typical parameter relationship.

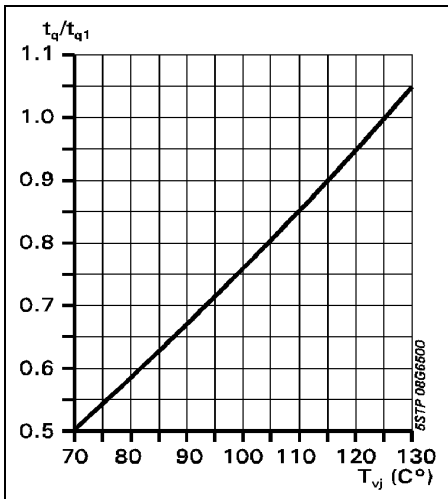

Fig. 12 $t_q/t_{q1} = f_1(T_j)$

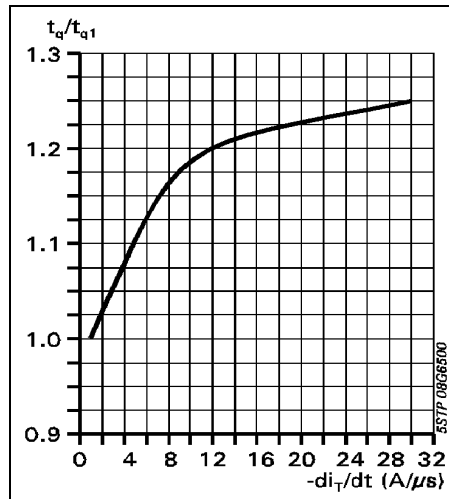

Fig. 13 $t_q/t_{q1} = f_2(-di/dt)$

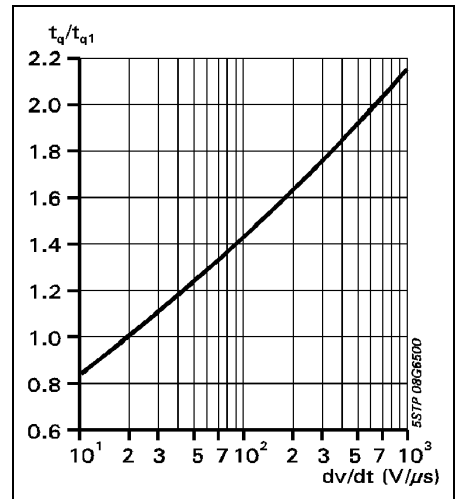

Fig. 14 $t_q/t_{q1} = f_3(dv/dt)$

$t_q = t_{q1} \cdot t_q/t_{q1} f_1(T_j) \cdot t_q/t_{q1} f_2(-di/dt) \cdot t_q/t_{q1} f_3(dv/dt)$
 t_{q1} : at normalized values (see page 2)
 t_q : at varying conditions

Turn-on and Turn-off losses

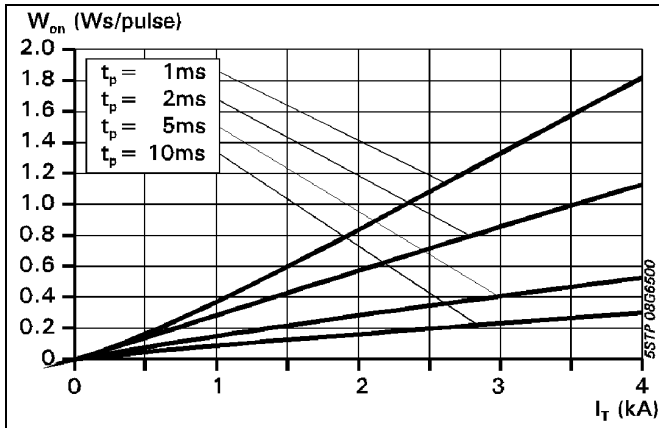

Fig. 15 $W_{on} = f(I_T, t_p)$, $T_j = 125^\circ\text{C}$.
Half sinusoidal waves.

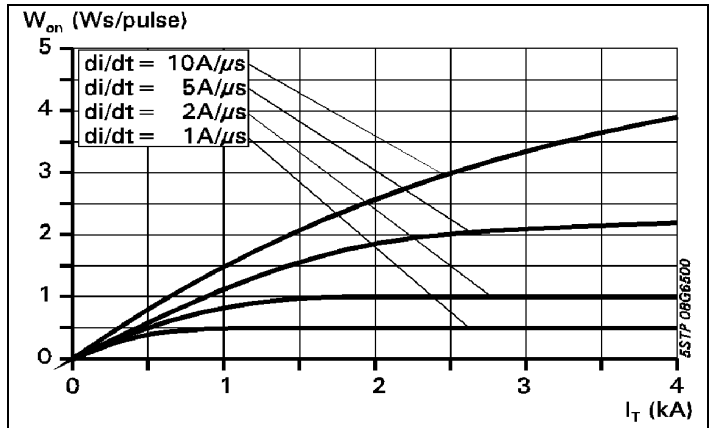

Fig. 16 $W_{on} = f(I_T, di/dt)$, $T_j = 125^\circ\text{C}$.
Rectangular waves.

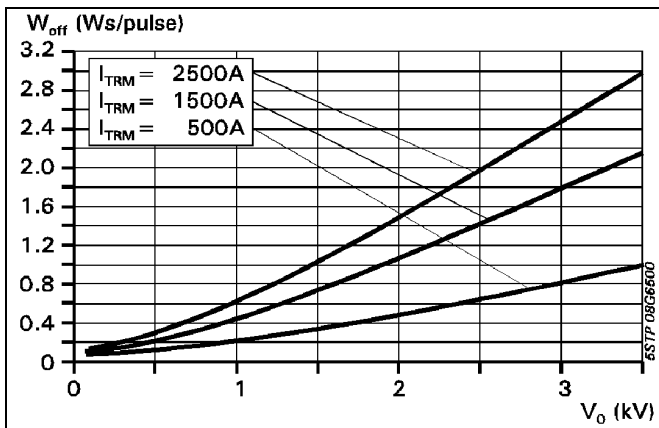

Fig. 17 $W_{off} = f(V_o, I_T)$, $T_j = 125^\circ\text{C}$.
Half sinusoidal waves. $t_p = 10$ ms.

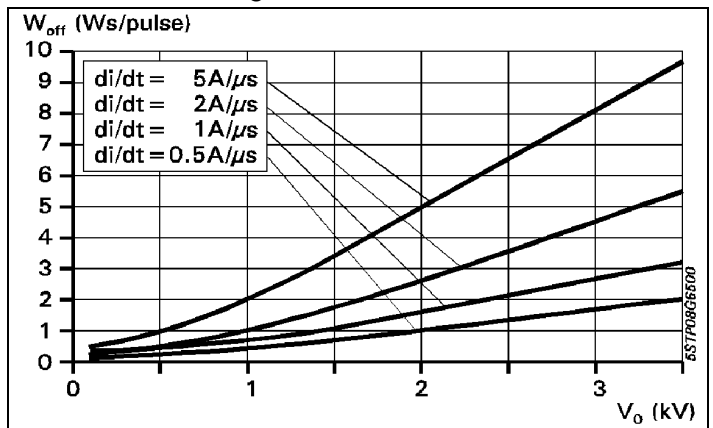

Fig. 18 $W_{off} = f(V_o, di/dt)$, $T_j = 125^\circ\text{C}$.
Rectangular waves.

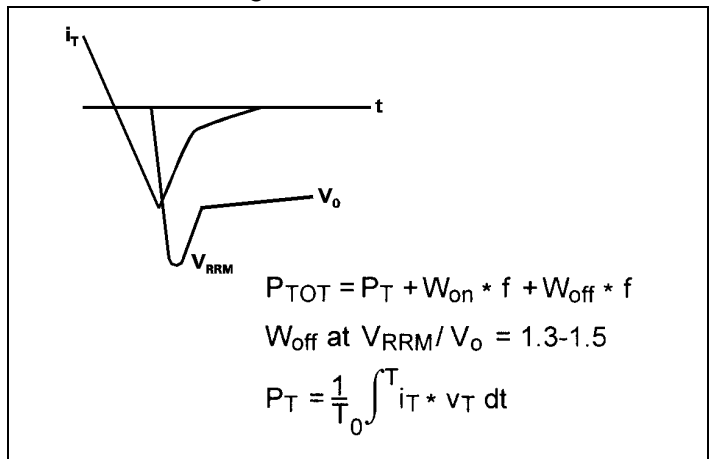

ABB Semiconductors reserves the right to change specifications without notice.



ABB Semiconductors AG
Fabrikstrasse 3
CH-5600 Lenzburg, Switzerland

Telephone +41 (0)62 888 6419
Fax +41 (0)62 888 6306
Email Info@ch.abb.com
Internet www.abbsem.com