



# 5STF 13F1220

Old part no. TR 918-1250-12

## Fast Thyristor

### Properties

- § Amplifying gate
- § High operational capability
- § Optimized turn-off parameters

### Applications

- § Power switching applications

### Key Parameters

$V_{DRM}, V_{RRM}$	= 1 200	V
$I_{TAV}$	= 1 252	A
$I_{TSM}$	= 21.0	kA
$V_{TO}$	= 1.772	V
$r_T$	= 0.248	mΩ
$t_q$	= 20.0	μs

### Types

	$V_{RRM}, V_{DRM}$
5STF 13F1220..1225	1 200 V
5STF 13F1020..1025	1 000 V

Conditions:  
 $T_j = -40 \div 125$  °C, half sine waveform,  
 $f = 50$  Hz

### Mechanical Data

$F_m$	Mounting force	22 ± 2 kN
$m$	Weight	0.48 kg
$D_s$	Surface creepage distance	25 mm
$D_a$	Air strike distance	13 mm

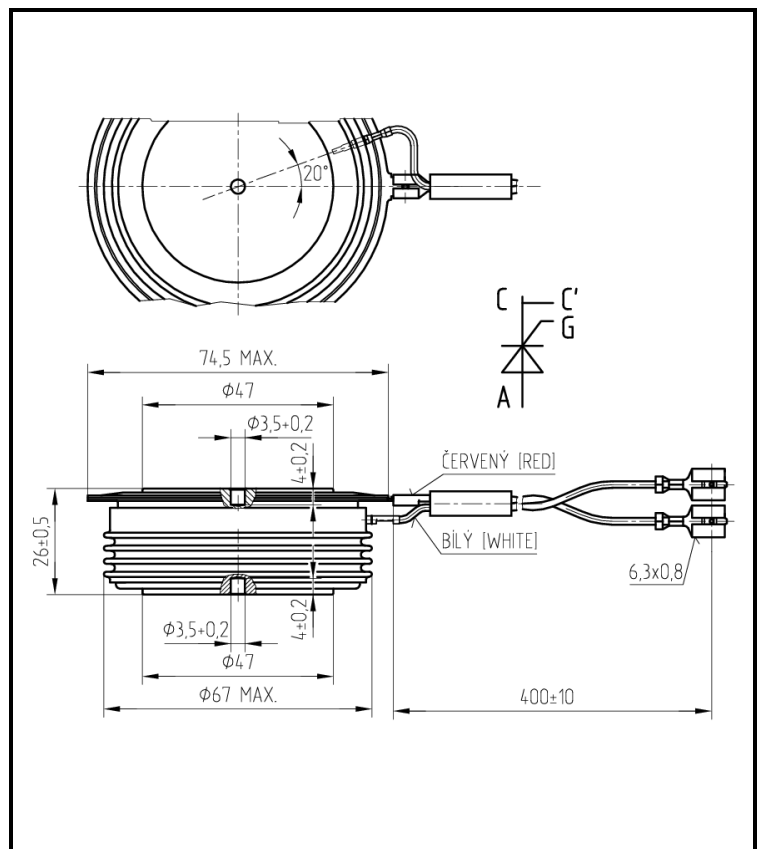

Fig. 1 Case



ABB s.r.o.

Novodvorska 1768/138a, 142 21 Praha 4, Czech Republic

tel.: +420 261 306 250, <http://www.abb.com/semiconductors>

<b>Maximum Ratings</b>			<b>Maximum Limits</b>	<b>Unit</b>
$V_{RRM}$ $V_{DRM}$	<b>Repetitive peak reverse and off-state voltage</b> $T_j = -40 \div 125 \text{ }^\circ\text{C}$	5STF 13F1220..1225 5STF 13F1020..1025	1 200 1 000	V
$I_{TRMS}$	<b>RMS on-state current</b> $T_c = 70 \text{ }^\circ\text{C}$ , half sine waveform, $f = 50 \text{ Hz}$		1 966	A
$I_{TAVm}$	<b>Average on-state current</b> $T_c = 70 \text{ }^\circ\text{C}$ , half sine waveform, $f = 50 \text{ Hz}$		1 252	A
$I_{TSM}$	<b>Peak non-repetitive surge</b> half sine pulse, $V_R = 0 \text{ V}$	$t_p = 10 \text{ ms}$ $t_p = 8.3 \text{ ms}$	21 000 22 400	A
$\int i^2 t$	<b>Limiting load integral</b> half sine pulse, $V_R = 0 \text{ V}$	$t_p = 10 \text{ ms}$ $t_p = 8.3 \text{ ms}$	2 205 000 2 080 000	A <sup>2</sup> s
$(di_T/dt)_{cr}$	<b>Critical rate of rise of on-state current</b> $I_T = I_{TAVm}$ , half sine waveform, $f = 50 \text{ Hz}$ , $V_D = 2/3 V_{DRM}$ , $t_r = 0.3 \text{ } \mu\text{s}$ , $I_{GT} = 2 \text{ A}$		800	A/ $\mu\text{s}$
$(dv_D/dt)_{cr}$	<b>Critical rate of rise of off-state voltage</b> $V_D = 2/3 V_{DRM}$		1 000	V/ $\mu\text{s}$
$P_{GAVm}$	<b>Maximum average gate power losses</b>		3	W
$I_{FGM}$	<b>Peak gate current</b>		10	A
$V_{FGM}$	<b>Peak gate voltage</b>		12	V
$V_{RGM}$	<b>Reverse peak gate voltage</b>		10	V
$T_{jmin} - T_{jmax}$	<b>Operating temperature range</b>		-40 $\div$ 125	$^\circ\text{C}$
$T_{stgmin} - T_{stgmax}$	<b>Storage temperature range</b>		-40 $\div$ 125	$^\circ\text{C}$

Unless otherwise specified  $T_j = 125 \text{ }^\circ\text{C}$

Characteristics		Value			Unit
		min.	typ.	max.	
$V_{TM}$	<b>Maximum peak on-state voltage</b> $I_{TM} = 2\ 000\ A$			<b>2.270</b>	<b>V</b>
$V_{T0}$	<b>Threshold voltage</b>			<b>1.772</b>	<b>V</b>
$r_T$	<b>Slope resistance</b> $I_{T1} = 1\ 963\ A, I_{T2} = 5\ 890\ A$			<b>0.248</b>	<b>mW</b>
$I_{DM}$	<b>Peak off-state current</b> $V_D = V_{DRM}$			<b>150</b>	<b>mA</b>
$I_{RM}$	<b>Peak reverse current</b> $V_R = V_{RRM}$			<b>150</b>	<b>mA</b>
$t_{gd}$	<b>Delay time</b> $T_j = 25\ ^\circ C, V_D = 0.4\ V_{DRM}, I_{TM} = I_{TAVm},$ $t_r = 0.3\ \mu s, I_{GT} = 2\ A$			<b>2.0</b>	<b><math>\mu s</math></b>
$t_q$	<b>Turn-off time</b> $I_T = 1\ 000\ A, di_T/dt = -50\ A/\mu s,$ $V_R = 100\ V, V_D = 2/3\ V_{DRM},$ $dv_D/dt = 50\ V/\mu s$	<b>group of <math>t_q</math></b> <b>5STF 13F1220</b> <b>5STF 13F1020</b>  <b>5STF 13F1225</b> <b>5STF 13F1025</b>		<b>20.0</b>  <b>25.0</b>	<b><math>\mu s</math></b>
$Q_{rr}$	<b>Recovery charge</b> <i>the same conditions as at <math>t_q</math></i>		<b>200</b>		<b><math>\mu C</math></b>
$I_{rrM}$	<b>Reverse recovery current</b> <i>the same conditions as at <math>t_q</math></i>		<b>100</b>		<b>A</b>
$I_H$	<b>Holding current</b>	$T_j = 25\ ^\circ C$ $T_j = 125\ ^\circ C$	<b>250</b> <b>150</b>		<b>mA</b>
$I_L$	<b>Latching current</b>	$T_j = 25\ ^\circ C$ $T_j = 125\ ^\circ C$	<b>1 500</b> <b>1 000</b>		<b>mA</b>
$V_{GT}$	<b>Gate trigger voltage</b> $V_D = 12V, I_T = 4\ A$	$T_j = -40\ ^\circ C$ $T_j = 25\ ^\circ C$ $T_j = 125\ ^\circ C$	<b>0.25</b>	<b>4</b> <b>3</b> <b>2</b>	<b>V</b>
$I_{GT}$	<b>Gate trigger current</b> $V_D = 12V, I_T = 4\ A$	$T_j = -40\ ^\circ C$ $T_j = 25\ ^\circ C$ $T_j = 125\ ^\circ C$	<b>10</b>	<b>500</b> <b>250</b> <b>150</b>	<b>mA</b>

Unless otherwise specified  $T_j = 125\ ^\circ C$

<b>Thermal Parameters</b>		<b>Value</b>	<b>Unit</b>
<b><math>R_{thjc}</math></b>	<b>Thermal resistance junction to case</b> <i>double side cooling</i>	<b>16.0</b>	<b>K/kW</b>
	<i>anode side cooling</i>	<b>25.0</b>	
	<i>cathode side cooling</i>	<b>45.0</b>	
<b><math>R_{thch}</math></b>	<b>Thermal resistance case to heatsink</b> <i>double side cooling</i>	<b>4.0</b>	<b>K/kW</b>
	<i>single side cooling</i>	<b>8.0</b>	

### Transient Thermal Impedance

Analytical function for transient thermal impedance

$$Z_{thjc} = \sum_{i=1}^4 R_i (1 - \exp(-t / \tau_i))$$

Conditions:

$F_m = 22 \pm 2$  kN, Double side cooled

Correction for periodic waveforms

180° sine:	add 1.3 K/kW
180° rectangular:	add 1.8 K/kW
120° rectangular:	add 3.0 K/kW
60° rectangular:	add 5.1 K/kW

<i>i</i>	1	2	3	4
$\tau_i$ (s)	0.4653	0.1533	0.0375	0.0034
$R_i$ (K/kW)	5.50	7.24	2.00	1.34

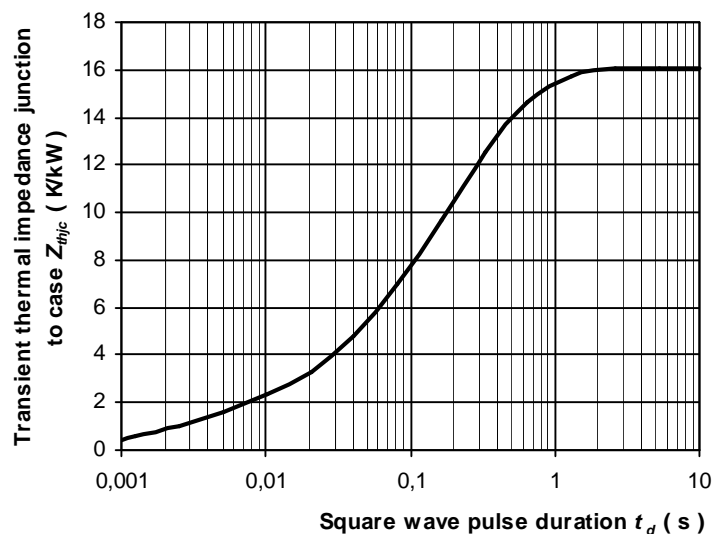

Fig. 2 Dependence transient thermal impedance junction to case on square pulse

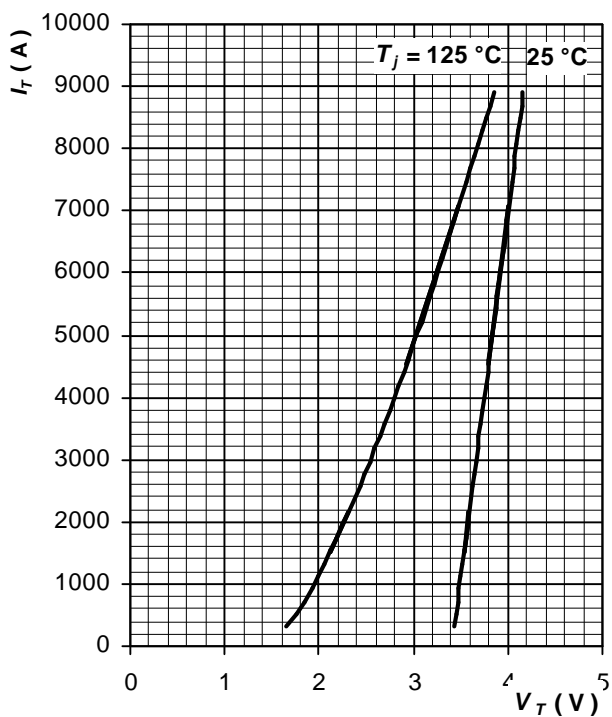

Fig. 3 Maximum on-state characteristics

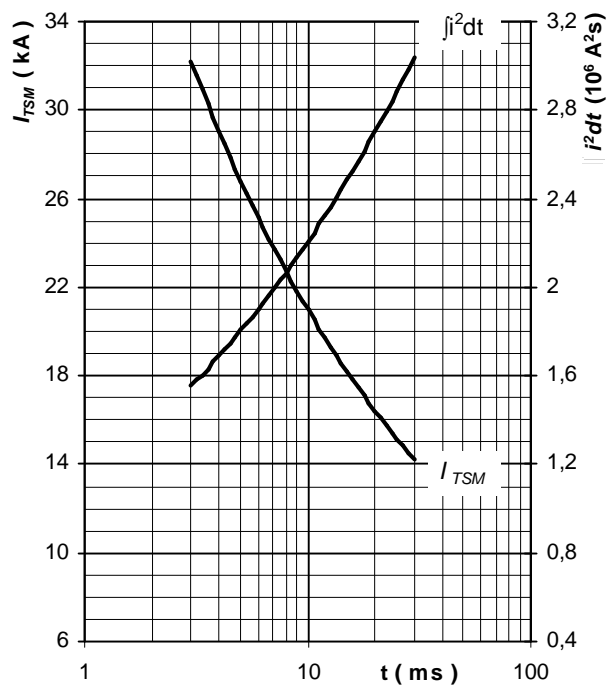

Fig. 4 Surge on-state current vs. pulse length, half sine wave, single pulse,  $V_R = 0\text{ V}$ ,  $T_j = T_{jmax}$

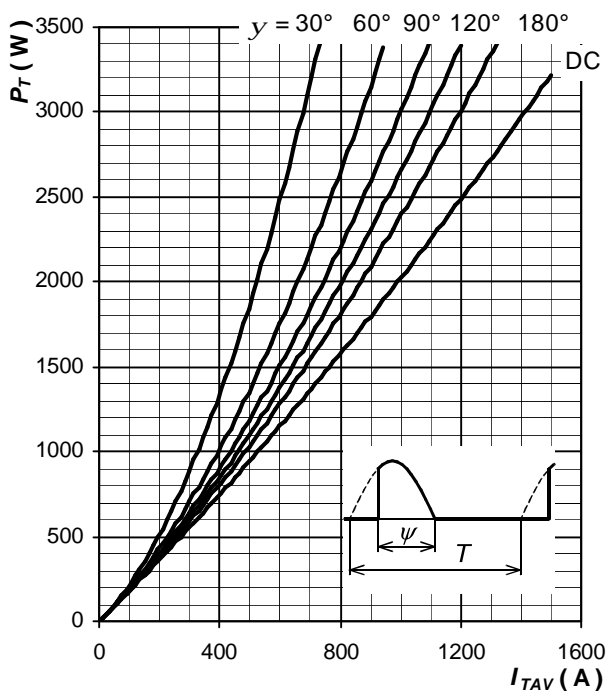

Fig. 5 On-state power loss vs. average on-state current, sine waveform,  $f = 50\text{ Hz}$ ,  $T = 1/f$

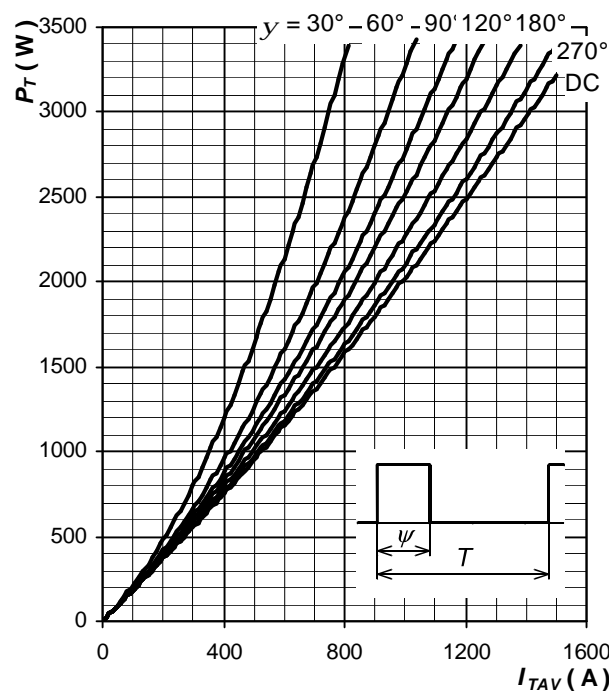

Fig. 6 On-state power loss vs. average on-state current, square waveform,  $f = 50\text{ Hz}$ ,  $T = 1/f$

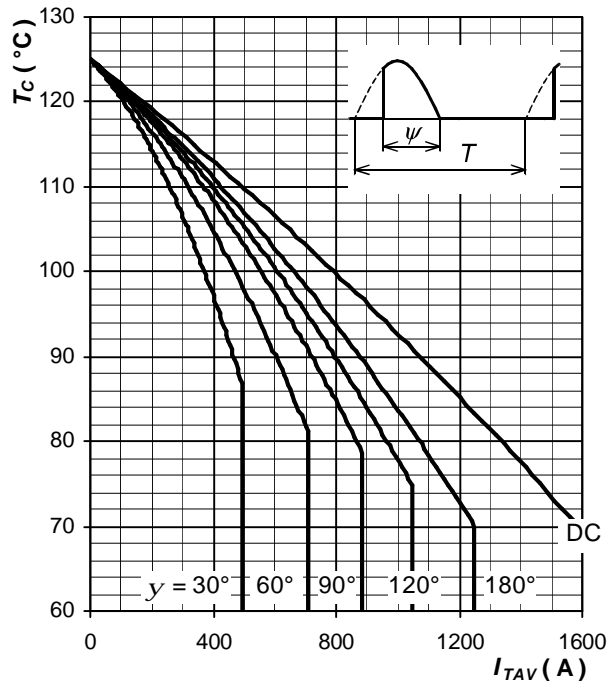

Fig. 7 Max. case temperature vs. aver. on-state current, sine waveform,  $f = 50$  Hz,  $T = 1/f$

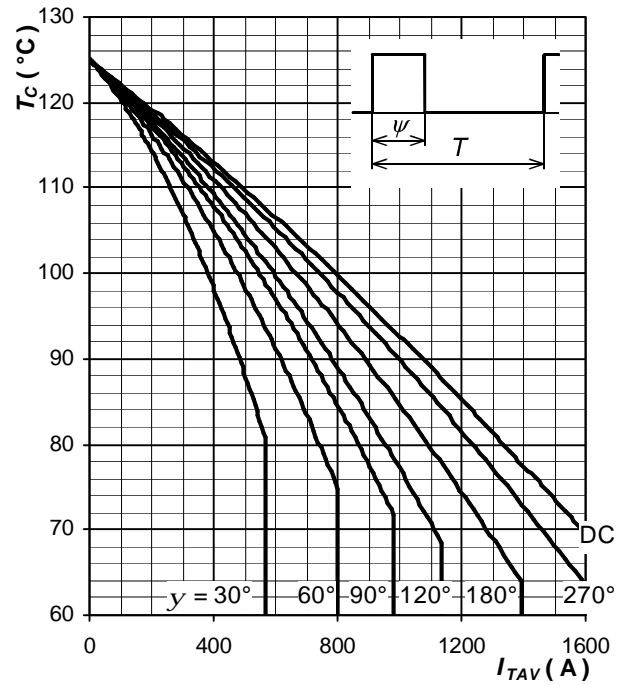

Fig. 8 Max. case temperature vs. aver. on-state current, square waveform,  $f = 50$  Hz,  $T = 1/f$

Notes: