



5STF 07T2032

Old part no. TR 907FC-680-20

Medium Frequency Thyristor

Properties

- § Amplifying gate
- § High operational capability
- § Optimized turn-on and turn-off parameters
- § High operating frequency

Applications

- § Power switching applications

Key Parameters

| | | |
|--------------------|---------|------------|
| V_{DRM}, V_{RRM} | = 2 000 | V |
| I_{TAV} | = 679 | A |
| I_{TSM} | = 9.0 | kA |
| V_{TO} | = 1.849 | V |
| r_T | = 0.306 | m Ω |
| t_q | = 32.0 | μ s |

Types

| | V_{RRM}, V_{DRM} |
|--------------------|--------------------|
| 5STF 07T2032..2040 | 2 000 V |
| 5STF 07T1832..1840 | 1 800 V |

Conditions:
 $T_j = -40 \div 125$ °C, half sine waveform,
 $f = 50$ Hz, note 1

Mechanical Data

| | | |
|-------|---------------------------|---------------|
| F_m | Mounting force | 10 \pm 2 kN |
| m | Weight | 0.20 kg |
| D_s | Surface creepage distance | 13 mm |
| D_a | Air strike distance | 8 mm |

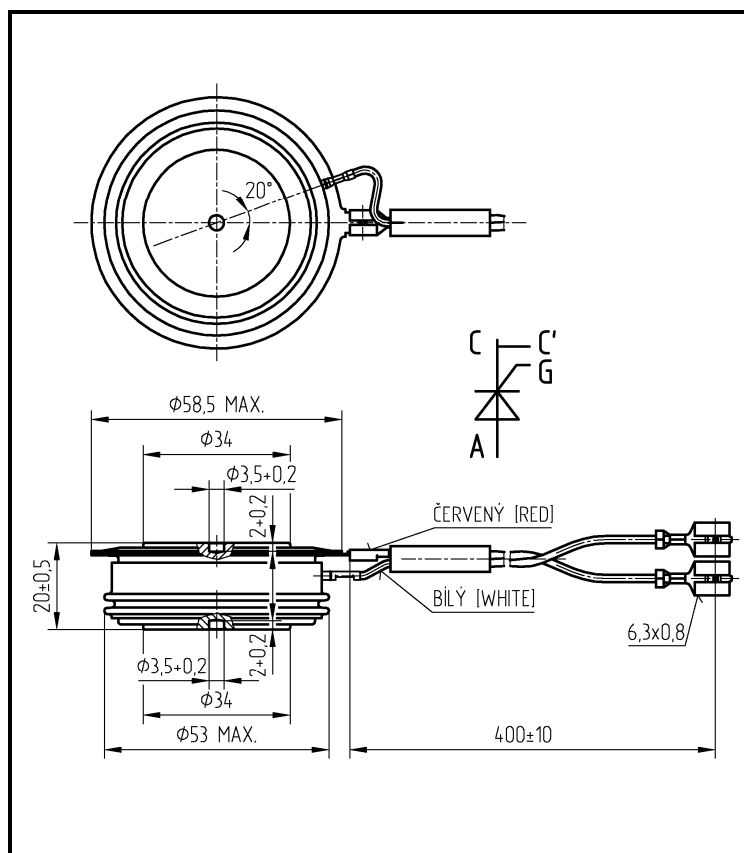

Fig. 1 Case



ABB s.r.o.

Novodvorska 1768/138a, 142 21 Praha 4, Czech Republic

tel.: +420 261 306 250, <http://www.abb.com/semiconductors>

| Maximum Ratings | | | Maximum Limits | Unit |
|---------------------------|---|---|-----------------------|------------------|
| V_{RRM} V_{DRM} | Repetitive peak reverse and off-state voltage $T_j = -40 \div 125 \text{ }^\circ\text{C}$, note 1 | 5STF 07T2032..2040 5STF 07T1832..1840 | 2 000 1 800 | V |
| I_{TRMS} | RMS on-state current $T_c = 70 \text{ }^\circ\text{C}$, half sine waveform, $f = 50 \text{ Hz}$ | | 1 067 | A |
| I_{TAVm} | Average on-state current $T_c = 70 \text{ }^\circ\text{C}$, half sine waveform, $f = 50 \text{ Hz}$ | | 679 | A |
| I_{TSM} | Peak non-repetitive surge half sine pulse, $V_R = 0 \text{ V}$ | $t_p = 10 \text{ ms}$ $t_p = 8.3 \text{ ms}$ | 9 000 9 610 | A |
| $\int i^2 t$ | Limiting load integral half sine pulse, $V_R = 0 \text{ V}$ | $t_p = 10 \text{ ms}$ $t_p = 8.3 \text{ ms}$ | 405 000 384 000 | A ² s |
| $(di_T/dt)_{cr}$ | Critical rate of rise of on-state current $I_T = I_{TAVm}$, half sine waveform, $f = 50 \text{ Hz}$, $V_D = 2/3 V_{DRM}$, $t_r = 0.3 \text{ } \mu\text{s}$, $I_{GT} = 2 \text{ A}$ | | 800 | A/ μs |
| $(dv_D/dt)_{cr}$ | Critical rate of rise of off-state voltage $V_D = 2/3 V_{DRM}$ | | 1 000 | V/ μs |
| P_{GAVm} | Maximum average gate power losses | | 3 | W |
| I_{FGM} | Peak gate current | | 10 | A |
| V_{FGM} | Peak gate voltage | | 12 | V |
| V_{RGM} | Reverse peak gate voltage | | 10 | V |
| $T_{jmin} - T_{jmax}$ | Operating temperature range | | -40 ÷ 125 | °C |
| $T_{stgmin} - T_{stgmax}$ | Storage temperature range | | -40 ÷ 125 | °C |

Unless otherwise specified $T_j = 125 \text{ }^\circ\text{C}$

Note 1: De-rating factor of 0.13% V_{RRM} or V_{DRM} per $^\circ\text{C}$ is applicable for T_j below $25 \text{ }^\circ\text{C}$

| Characteristics | | Value | | | Unit |
|-----------------|---|--|-------------|---|---------|
| | | min. | typ. | max. | |
| V_{TM} | Maximum peak on-state voltage $I_{TM} = 1\ 500\ A$ | | | 2.310 | V |
| V_{T0} | Threshold voltage | | | 1.849 | V |
| r_T | Slope resistance $I_{T1} = 1\ 068\ A, I_{T2} = 3\ 204\ A$ | | | 0.306 | mW |
| I_{DM} | Peak off-state current $V_D = V_{DRM}$ | | | 70 | mA |
| I_{RM} | Peak reverse current $V_R = V_{RRM}$ | | | 70 | mA |
| t_{gd} | Delay time $T_j = 25\ ^\circ C, V_D = 0.4\ V_{DRM}, I_{TM} = I_{TAVm},$ $t_r = 0.3\ \mu s, I_{GT} = 2\ A$ | | | 2.0 | μs |
| t_{q1} | Turn-off time $I_T = 500\ A, di_T/dt = -50\ A/\mu s,$ $V_R = 100\ V, V_D = 2/3\ V_{DRM},$ $dv_D/dt = 50\ V/\mu s$ | group of t_q 5STF 07T2032 5STF 07T1832 5STF 07T2040 5STF 07T1840 | | 32.0 40.0 | μs |
| Q_{rr} | Recovery charge <i>the same conditions as at t_{q1}</i> | | | 440 | μC |
| I_{rrM} | Reverse recovery current <i>the same conditions as at t_{q1}</i> | | | 140 | A |
| I_H | Holding current | $T_j = 25\ ^\circ C$ $T_j = 125\ ^\circ C$ | | 250 150 | mA |
| I_L | Latching current | $T_j = 25\ ^\circ C$ $T_j = 125\ ^\circ C$ | | 1\ 500 1\ 000 | mA |
| V_{GT} | Gate trigger voltage $V_D = 12V, I_T = 4\ A$ | $T_j = -40\ ^\circ C$ $T_j = 25\ ^\circ C$ $T_j = 125\ ^\circ C$ | 0.25 | 4 3 2 | V |
| I_{GT} | Gate trigger current $V_D = 12V, I_T = 4\ A$ | $T_j = -40\ ^\circ C$ $T_j = 25\ ^\circ C$ $T_j = 125\ ^\circ C$ | 10 | 1000 500 300 | mA |

Unless otherwise specified $T_j = 125\ ^\circ C$

| Thermal Parameters | | Value | Unit |
|------------------------------|--|--------------|-------------|
| R_{thjc} | Thermal resistance junction to case <i>double side cooling</i> | 32.0 | K/kW |
| | <i>anode side cooling</i> | 52.0 | |
| | <i>cathode side cooling</i> | 83.0 | |
| R_{thch} | Thermal resistance case to heatsink <i>double side cooling</i> | 10.0 | K/kW |
| | <i>single side cooling</i> | 20.0 | |

Transient Thermal Impedance

Analytical function for transient thermal impedance

$$Z_{thjc} = \sum_{i=1}^5 R_i (1 - \exp(-t/\tau_i))$$

Conditions:

$F_m = 10 \pm 2$ kN, Double side cooled

Correction for periodic waveforms

| | |
|-------------------|--------------|
| 180° sine: | add 2.3 K/kW |
| 180° rectangular: | add 3.1 K/kW |
| 120° rectangular: | add 5.2 K/kW |
| 60° rectangular: | add 8.7 K/kW |

| i | 1 | 2 | 3 | 4 | 5 |
|--------------|--------|--------|--------|--------|--------|
| t_i (s) | 0.4857 | 0.2162 | 0.0762 | 0.0043 | 0.0006 |
| R_i (K/kW) | 13.07 | 8.03 | 8.20 | 2.57 | 0.13 |

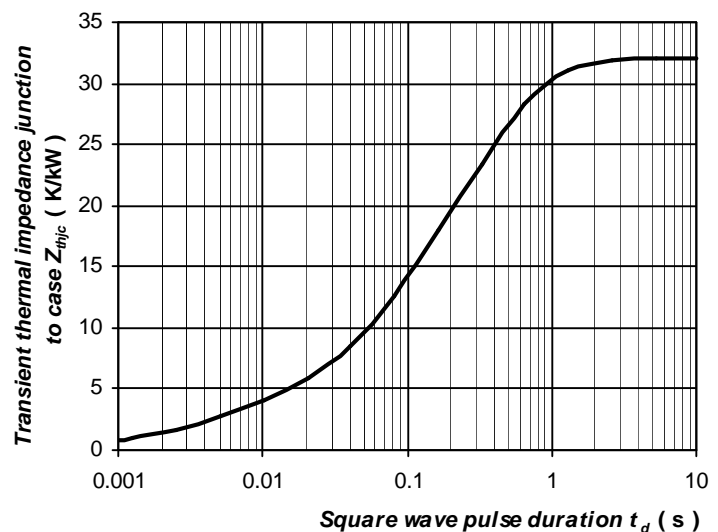

Fig. 2 Dependence transient thermal impedance junction to case on square pulse

On-State Characteristics

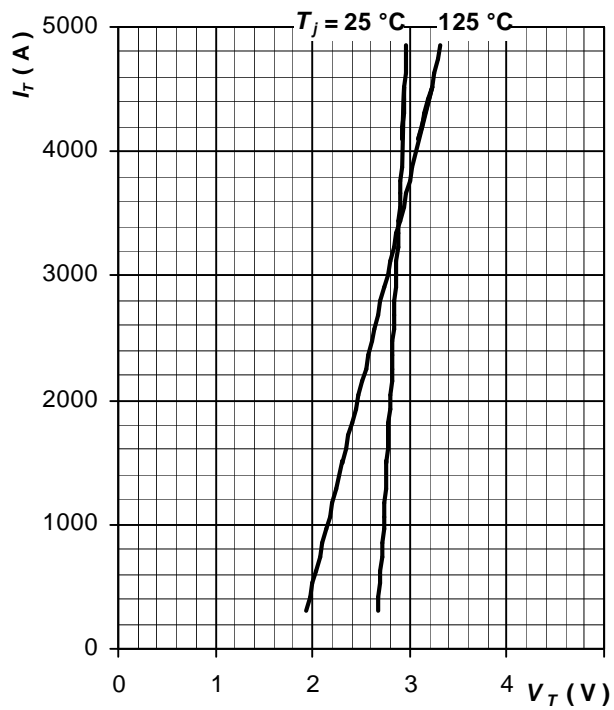

Fig. 3 Maximum on-state characteristics

Gate Trigger Characteristics

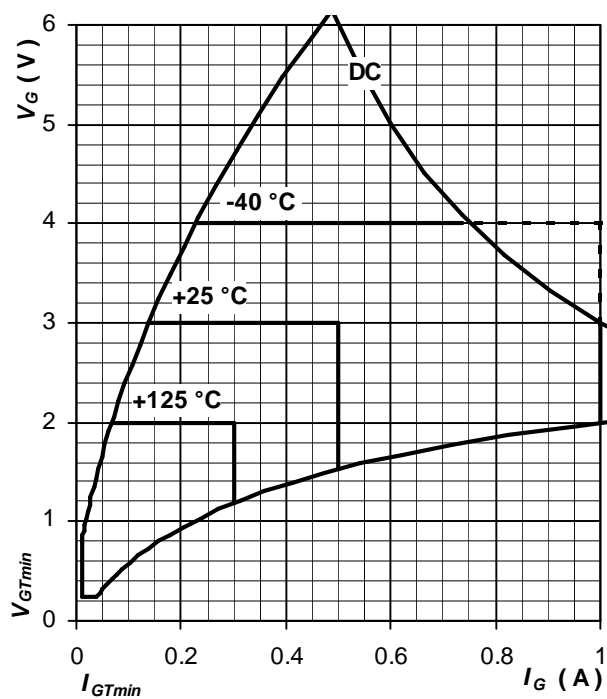

Fig. 4 Gate trigger characteristics

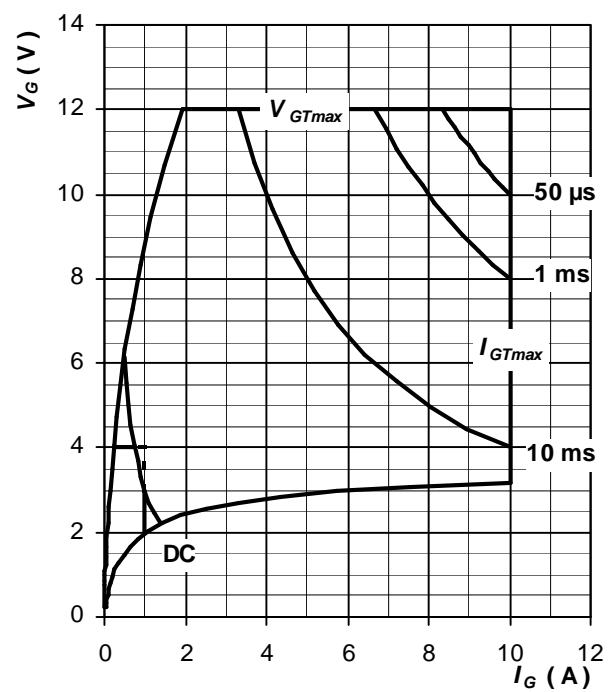

Fig. 5 Maximum peak gate power loss

Surge Characteristics

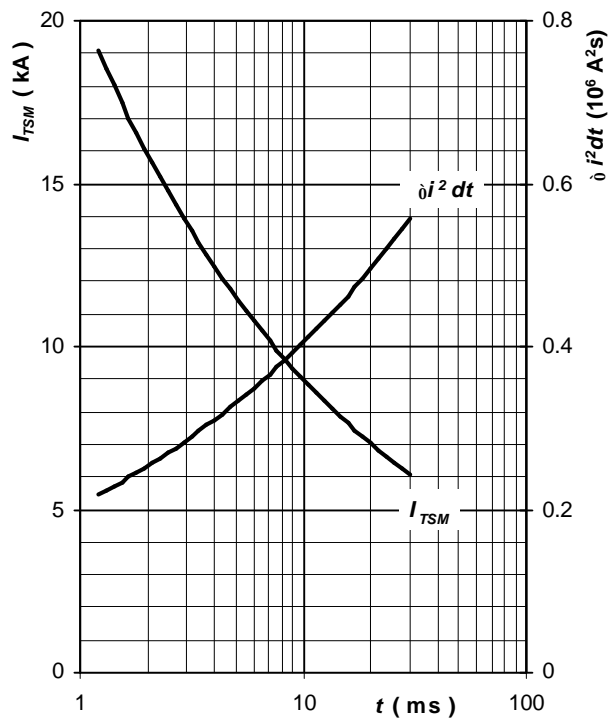

Fig. 6 Surge on-state current vs. pulse length, half sine wave, single pulse, $V_R = 0 \text{ V}$, $T_j = T_{jmax}$

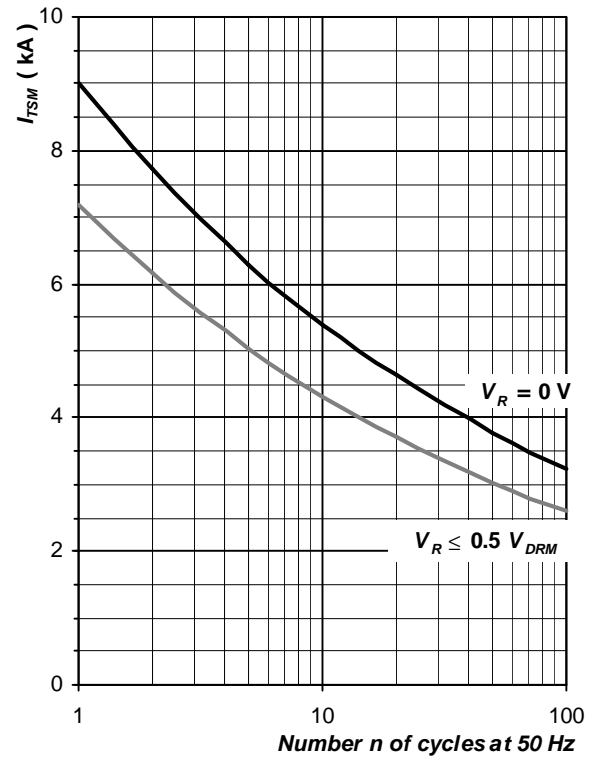

Fig. 7 Surge on-state current vs. number of pulses, half sine wave, $T_j = T_{jmax}$

Power Loss and Maximum Case Temperature Characteristics

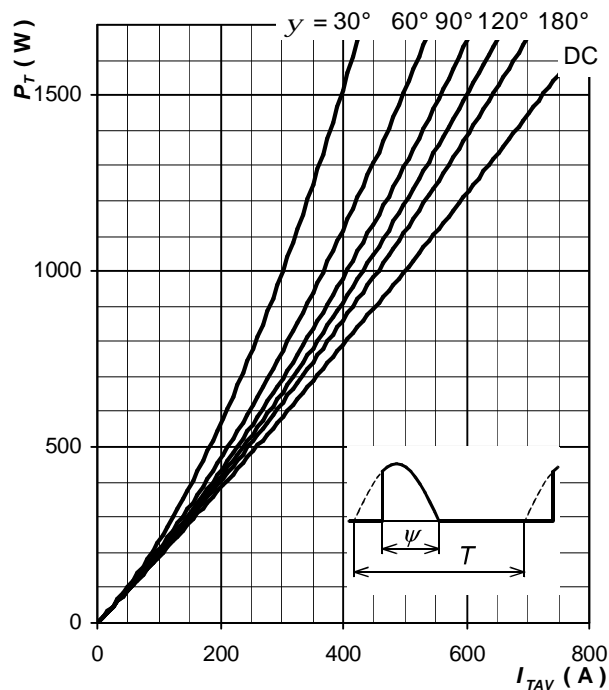

Fig. 8 On-state power loss vs. average on-state current, sine waveform, $f = 50 \text{ Hz}$, $T = 1/f$

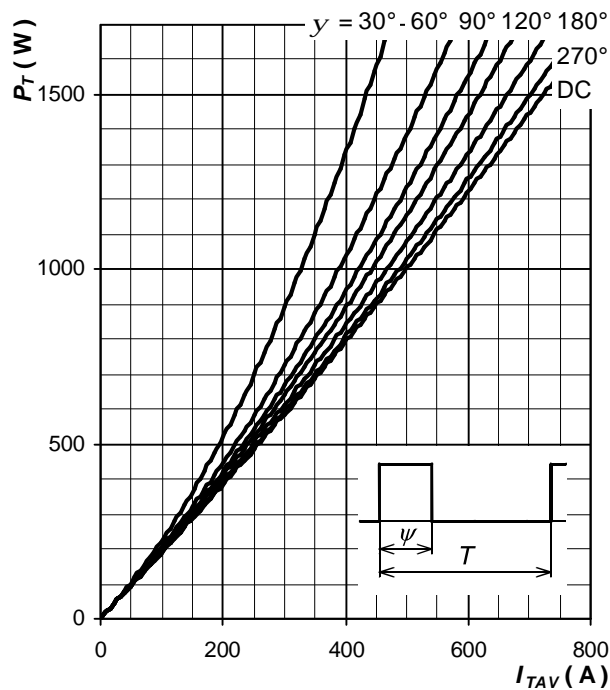

Fig. 9 On-state power loss vs. average on-state current, square waveform, $f = 50 \text{ Hz}$, $T = 1/f$

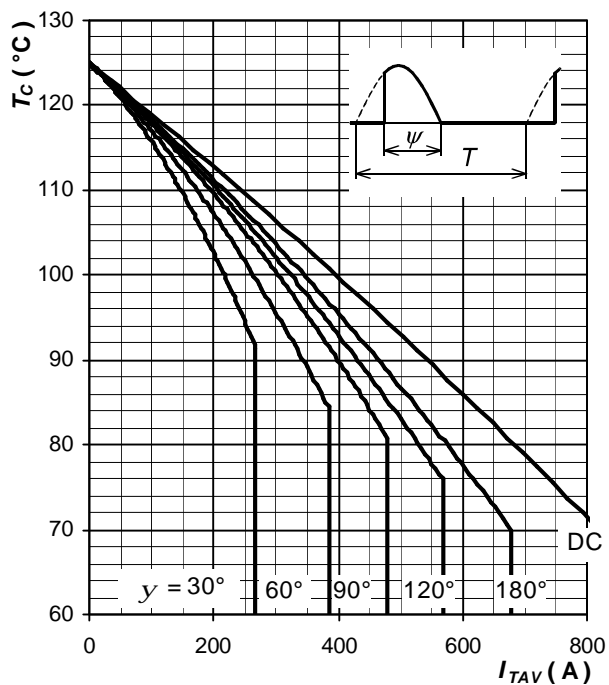

Fig. 10 Max. case temperature vs. aver. on-state current, sine waveform, $f = 50 \text{ Hz}$, $T = 1/f$

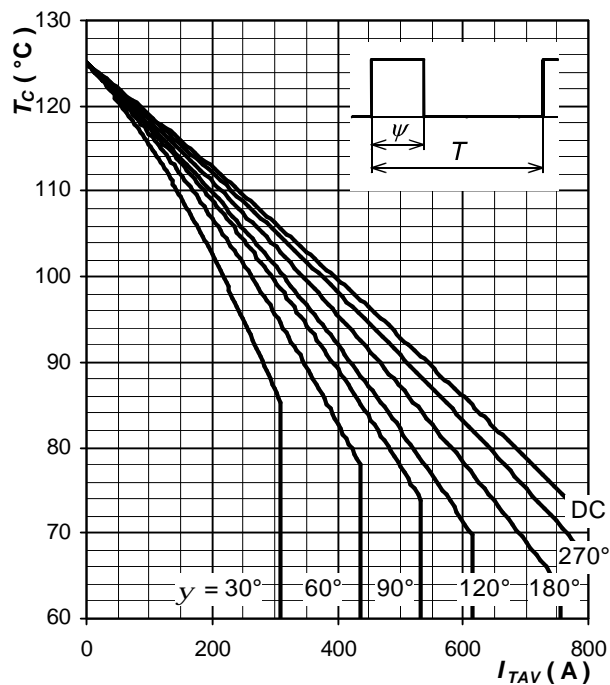

Fig. 11 Max. case temperature vs. aver. on-state current, square waveform, $f = 50 \text{ Hz}$, $T = 1/f$

Note 2: Figures number 8 , 11 have been calculated without considering any turn-on and turn-off losses. They are valid for $f = 50$ or 60 Hz operation.

Turn-off Time, Parameter Relationship

Maximum values of turn-off time at application specific conditions are given by using this formula:

$$t_q = t_{q1} \cdot \frac{t_q(T_j)}{t_{q1}} \cdot \frac{t_q(dv_D/dt)}{t_{q1}} \cdot \frac{t_q(-di_T/dt)}{t_{q1}}$$

where:

t_{q1} is turn-off time at standard conditions, see section "Characteristics"

$\frac{t_q(T_j)}{t_{q1}}$ is factor to be taken from fig. 12

$\frac{t_q(dv_D/dt)}{t_{q1}}$ is factor to be taken from fig. 13

$\frac{t_q(-di_T/dt)}{t_{q1}}$ is factor to be taken from fig. 14

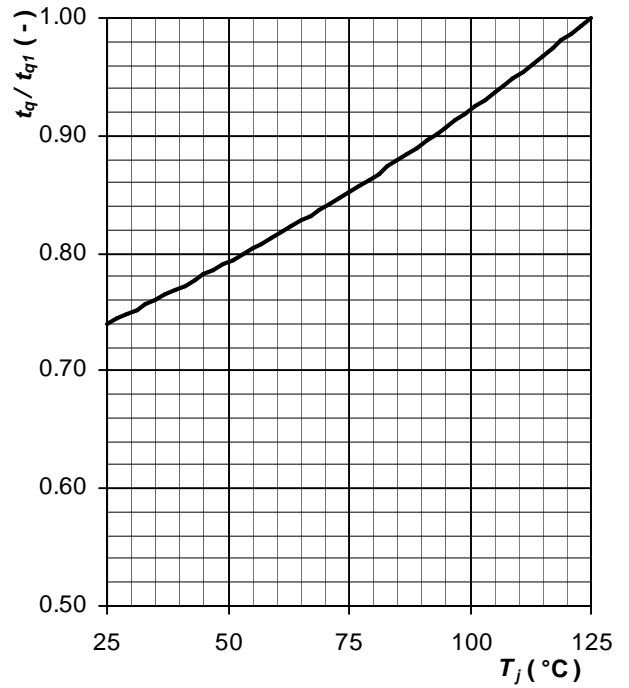

Fig. 12 Normalised maximum turn-off time vs. junction temperature

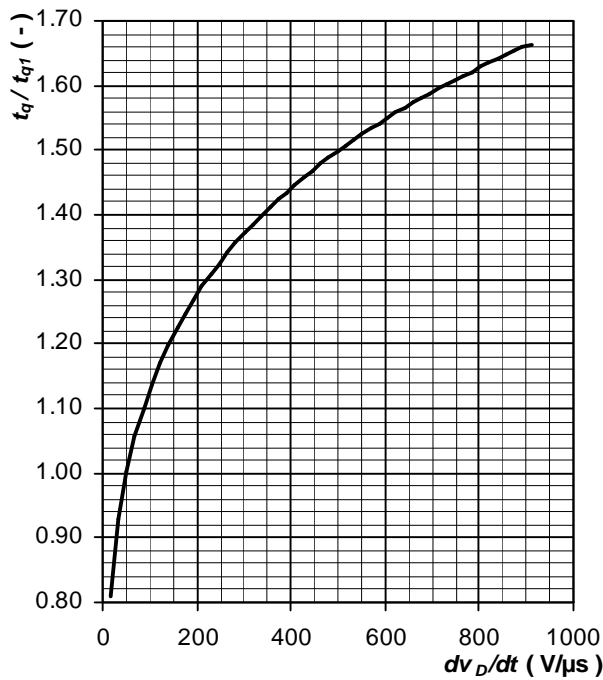

Fig. 13 Normalised maximum turn-off time vs. rate of rise of off-state voltage

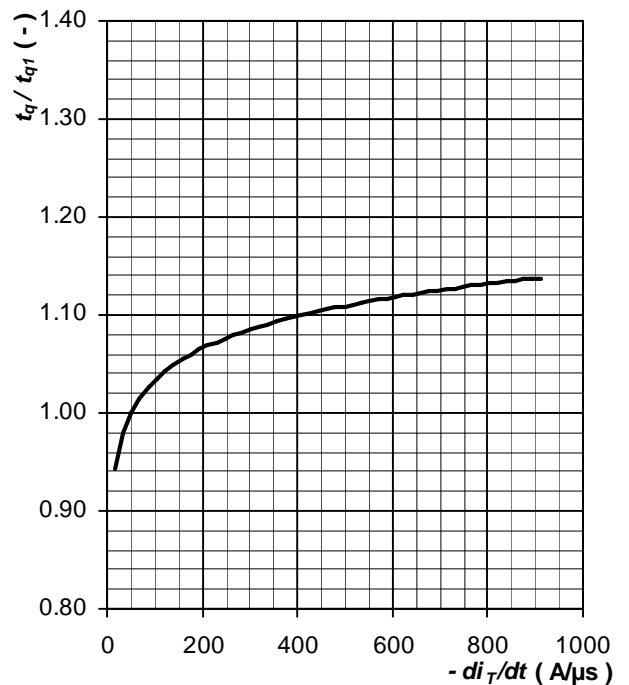

Fig. 14 Normalised maximum turn-off time vs. rate of fall of on-state current

Turn-on Characteristics

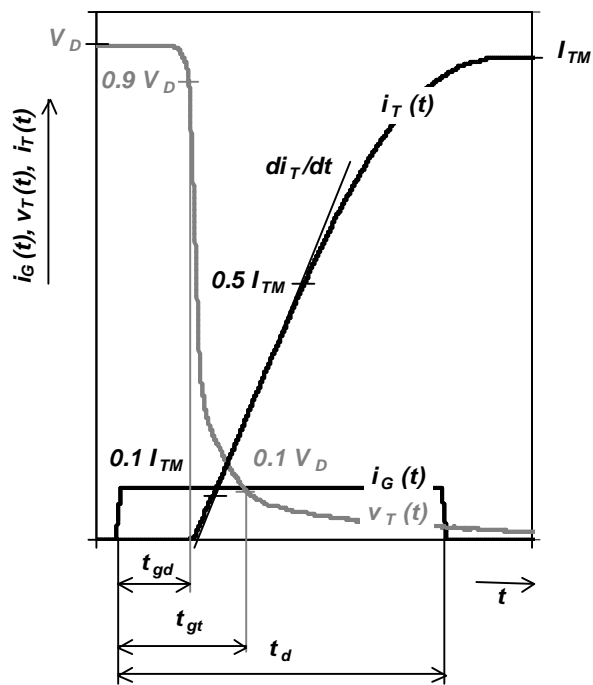

Fig. 15 Typical waveforms and definition of symbols at turn-on of a thyristor

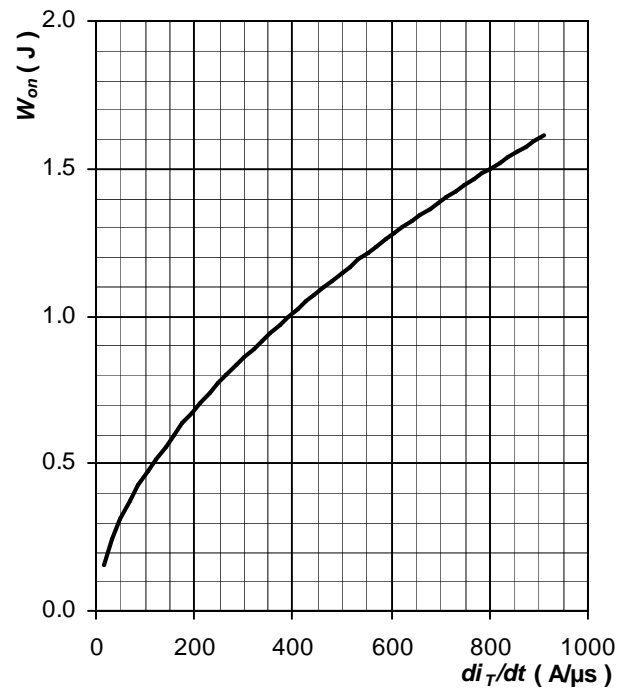

Fig. 16 Maximum turn-on energy per pulse vs. rate of rise on-state current, $T_j = T_{jmax}$

Turn-off Characteristics

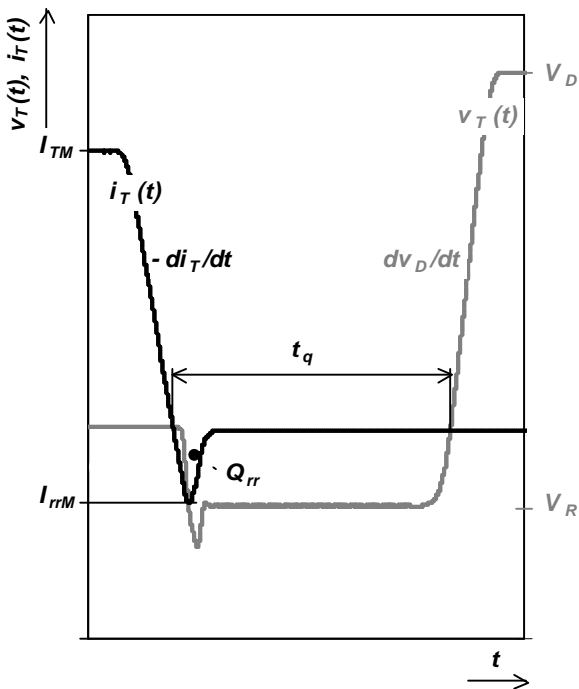

Fig. 17 Typical waveforms and definition of symbols at turn-off of a thyristor, inductive switching without RC snubber

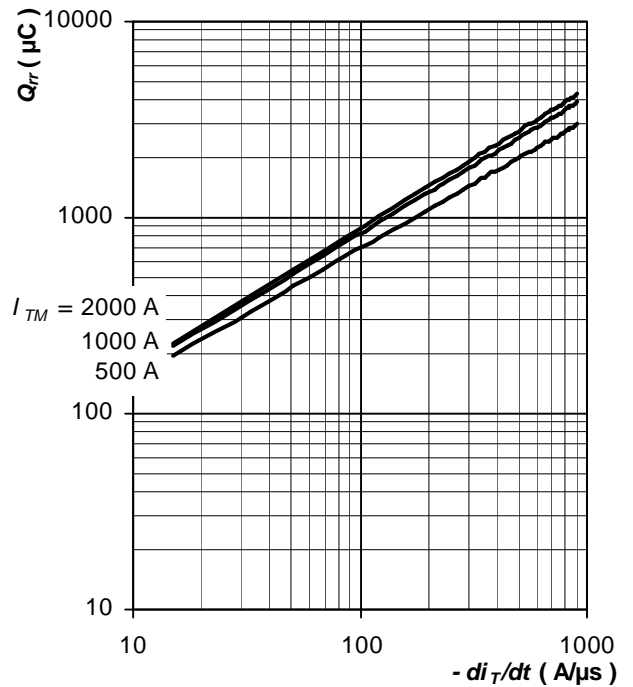

Fig. 18 Max. recovered charge vs. rate of fall on-state current, trapezoid pulse, $V_R = 100 \text{ V}$, $T_j = T_{jmax}$

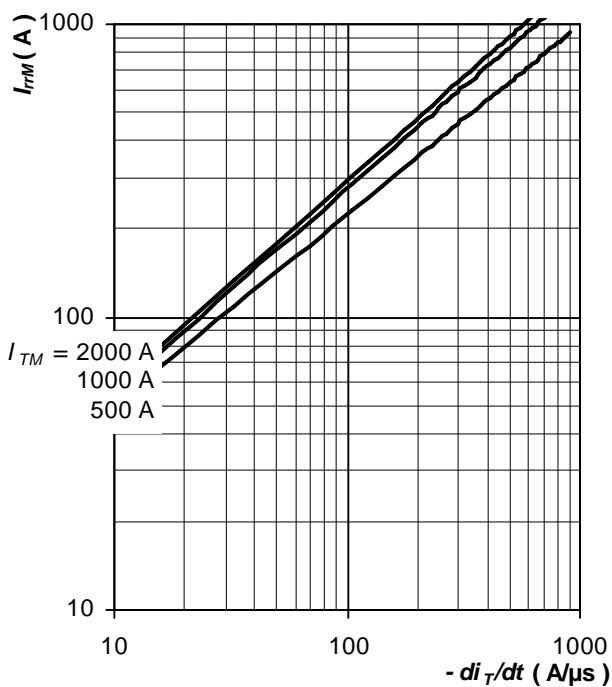

Fig. 19 Max. reverse recovery current vs. rate of fall on-state current, trapezoid pulse, $V_R = 100 \text{ V}$, $T_j = T_{jmax}$

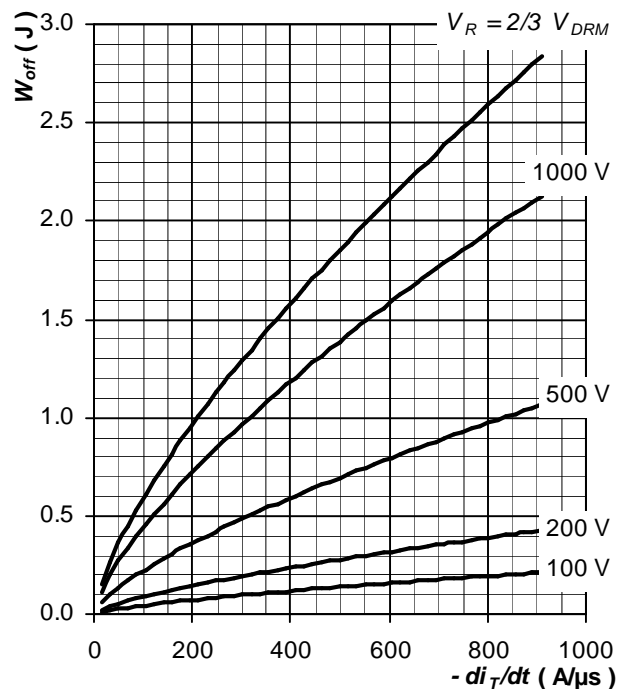

Fig. 20 Maximum turn-off energy per pulse vs. rate of fall on-state current, trapezoid pulse, inductive switching without RC snubber, $I_{TM} = 2000 \text{ A}$, $T_j = T_{jmax}$

Frequency Ratings

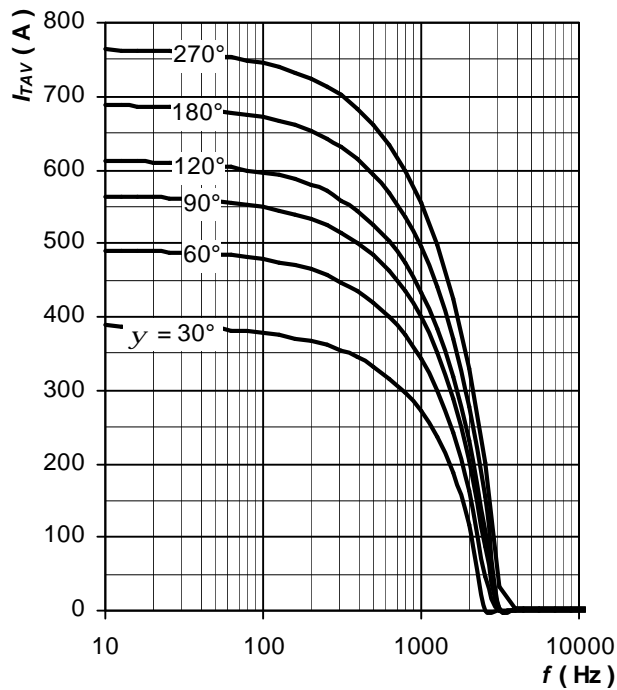

Fig. 21 Average on-state current vs. frequency, trapezoid waveform, $T_C = 70\text{ }^\circ\text{C}$, $di_T/dt = \pm 100\text{ A}/\mu\text{s}$, $V_R = 100\text{ V}$

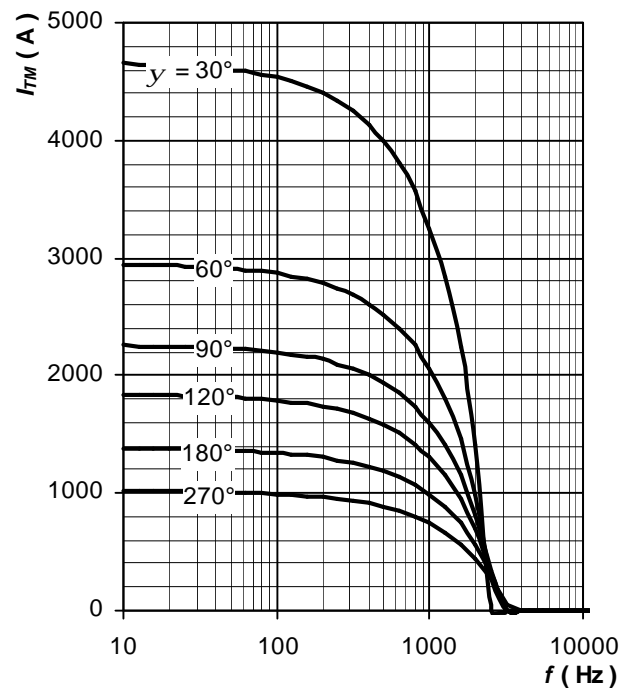

Fig. 22 Maximum on-state current vs. frequency, trapezoid waveform, $T_C = 70\text{ }^\circ\text{C}$, $di_T/dt = \pm 100\text{ A}/\mu\text{s}$, $V_R = 100\text{ V}$

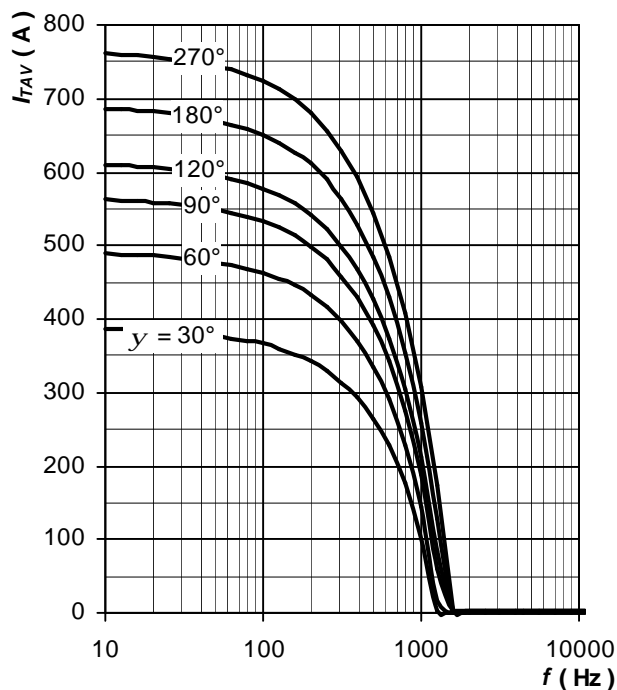

Fig. 23 Average on-state current vs. frequency, trapezoid waveform, $T_C = 70\text{ }^\circ\text{C}$, $di_T/dt = \pm 100\text{ A}/\mu\text{s}$, $V_R = 2/3 V_{DRM}$

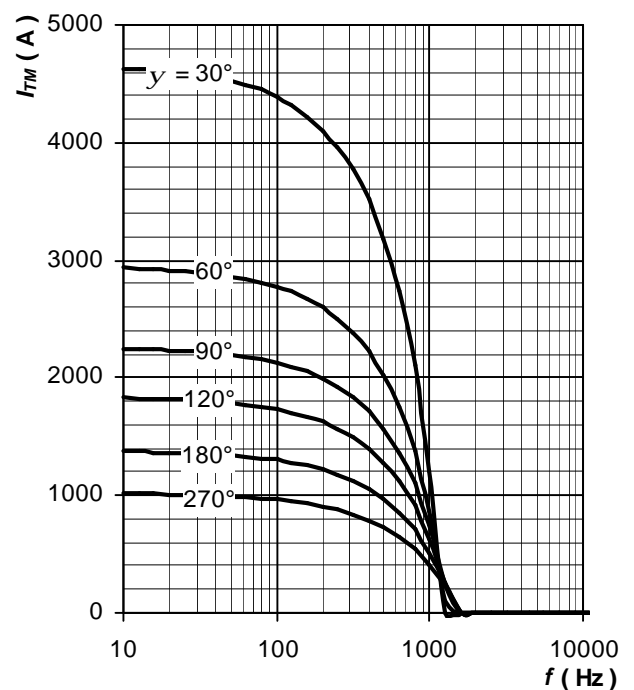

Fig. 24 Maximum on-state current vs. frequency, trapezoid waveform, $T_C = 70\text{ }^\circ\text{C}$, $di_T/dt = \pm 100\text{ A}/\mu\text{s}$, $V_R = 2/3 V_{DRM}$

Frequency Ratings

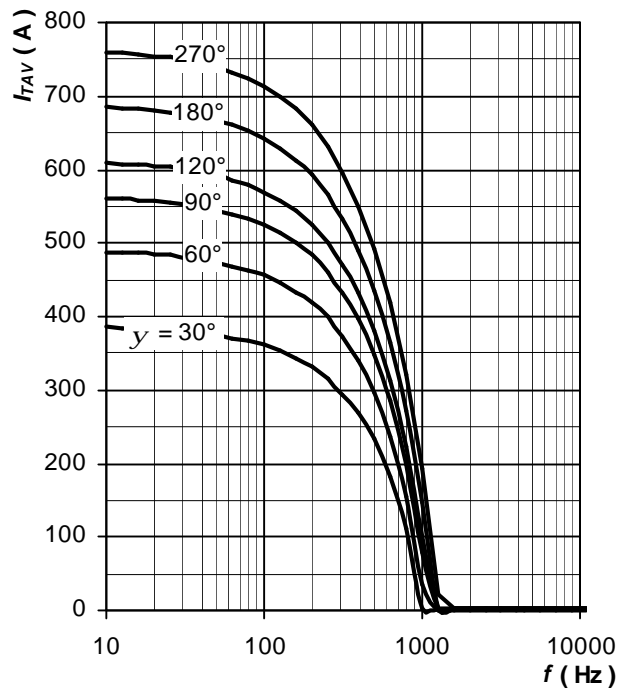

Fig. 25 Average on-state current vs. frequency, trapezoid waveform, $T_C = 70\text{ }^\circ\text{C}$, $di_T/dt = \pm 500\text{ A}/\mu\text{s}$, $V_R = 100\text{ V}$

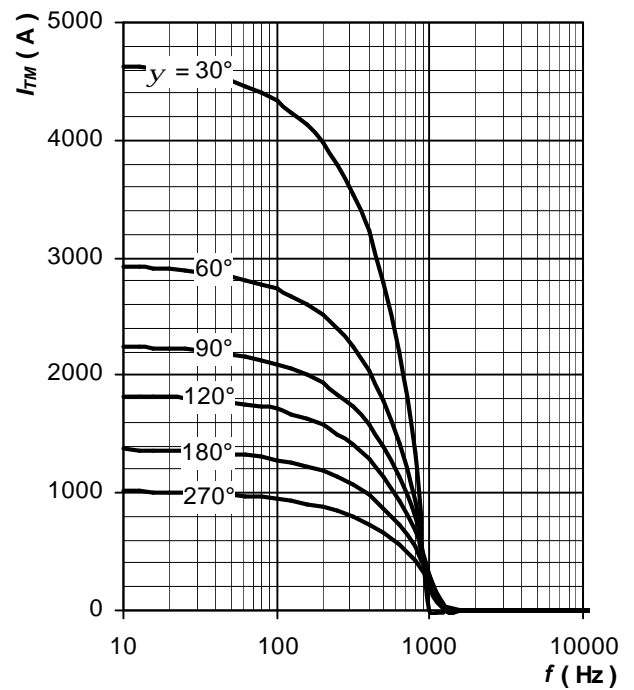

Fig. 26 Maximum on-state current vs. frequency, trapezoid waveform, $T_C = 70\text{ }^\circ\text{C}$, $di_T/dt = \pm 500\text{ A}/\mu\text{s}$, $V_R = 100\text{ V}$

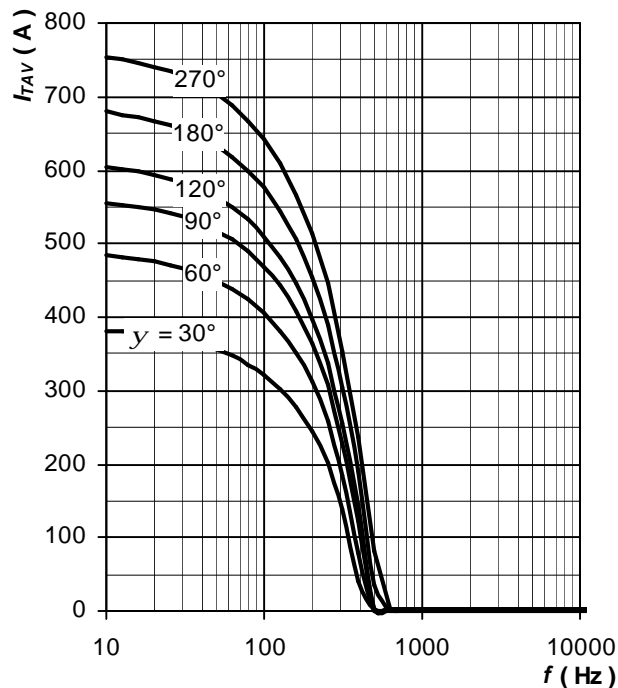

Fig. 27 Average on-state current vs. frequency, trapezoid waveform, $T_C = 70\text{ }^\circ\text{C}$, $di_T/dt = \pm 500\text{ A}/\mu\text{s}$, $V_R = 2/3 V_{DRM}$

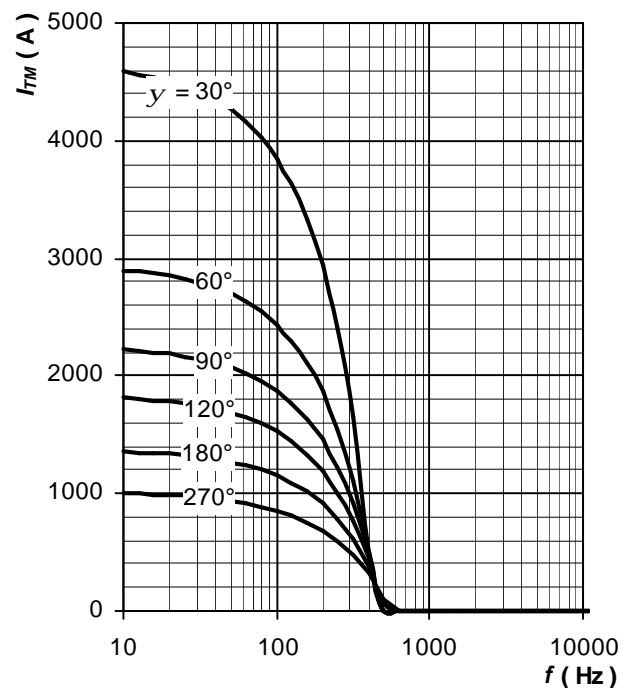

Fig. 28 Maximum on-state current vs. frequency, trapezoid waveform, $T_C = 70\text{ }^\circ\text{C}$, $di_T/dt = \pm 500\text{ A}/\mu\text{s}$, $V_R = 2/3 V_{DRM}$

Frequency Ratings

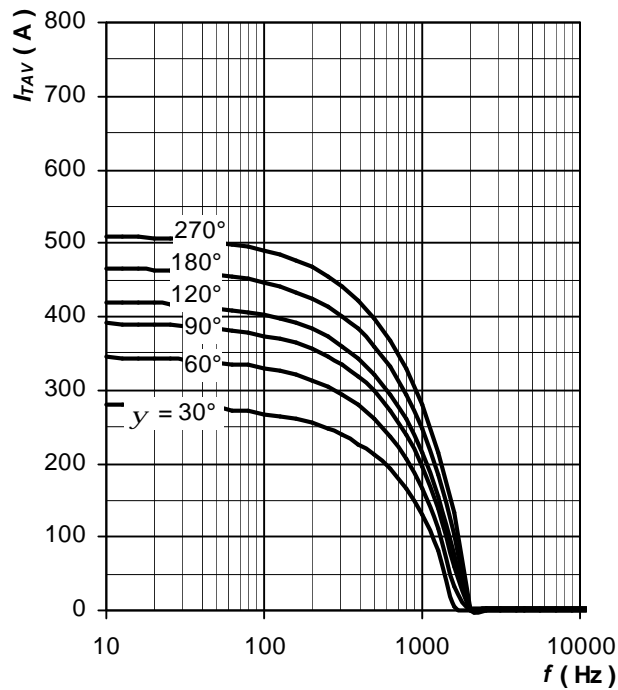

Fig. 29 Average on-state current vs. frequency, trapezoid waveform, $T_C = 90\text{ }^\circ\text{C}$, $di_T/dt = \pm 100\text{ A}/\mu\text{s}$, $V_R = 100\text{ V}$

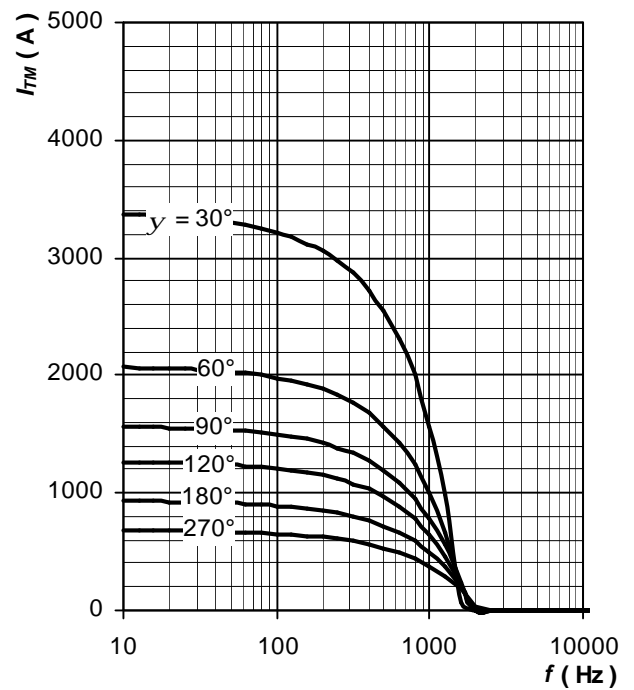

Fig. 30 Maximum on-state current vs. frequency, trapezoid waveform, $T_C = 90\text{ }^\circ\text{C}$, $di_T/dt = \pm 100\text{ A}/\mu\text{s}$, $V_R = 100\text{ V}$

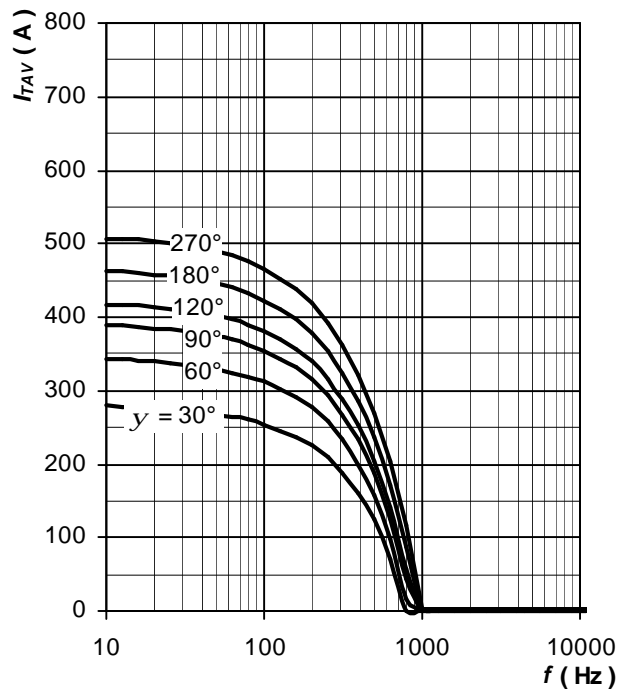

Fig. 31 Average on-state current vs. frequency, trapezoid waveform, $T_C = 90\text{ }^\circ\text{C}$, $di_T/dt = \pm 100\text{ A}/\mu\text{s}$, $V_R = 2/3 V_{DRM}$

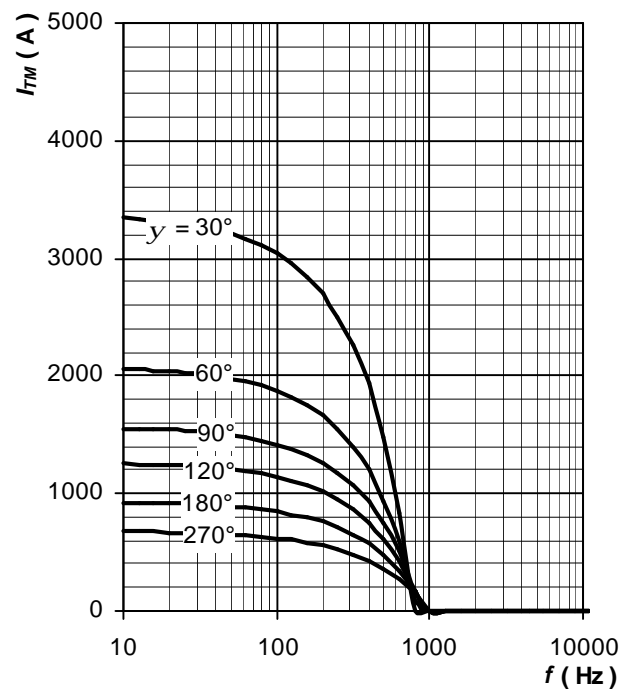

Fig. 32 Maximum on-state current vs. frequency, trapezoid waveform, $T_C = 90\text{ }^\circ\text{C}$, $di_T/dt = \pm 100\text{ A}/\mu\text{s}$, $V_R = 2/3 V_{DRM}$

Frequency Ratings

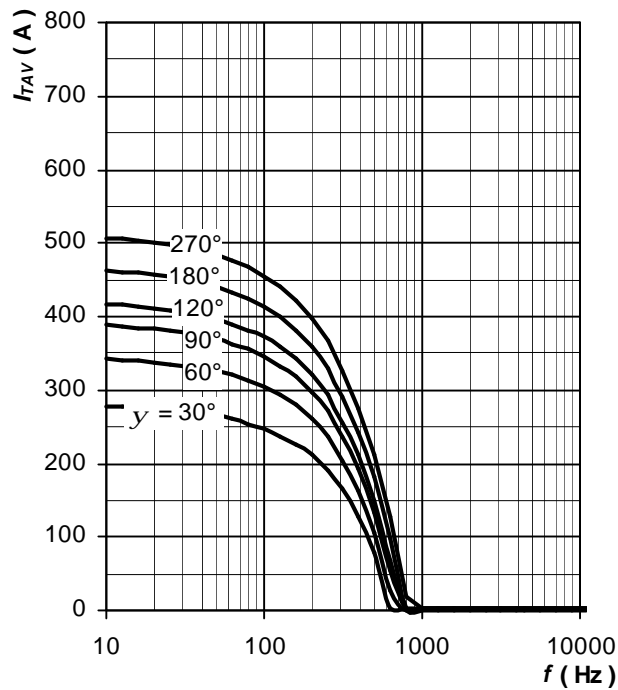

Fig. 33 Average on-state current vs. frequency, trapezoid waveform, $T_C = 90\text{ }^\circ\text{C}$, $di_T/dt = \pm 500\text{ A}/\mu\text{s}$, $V_R = 100\text{ V}$

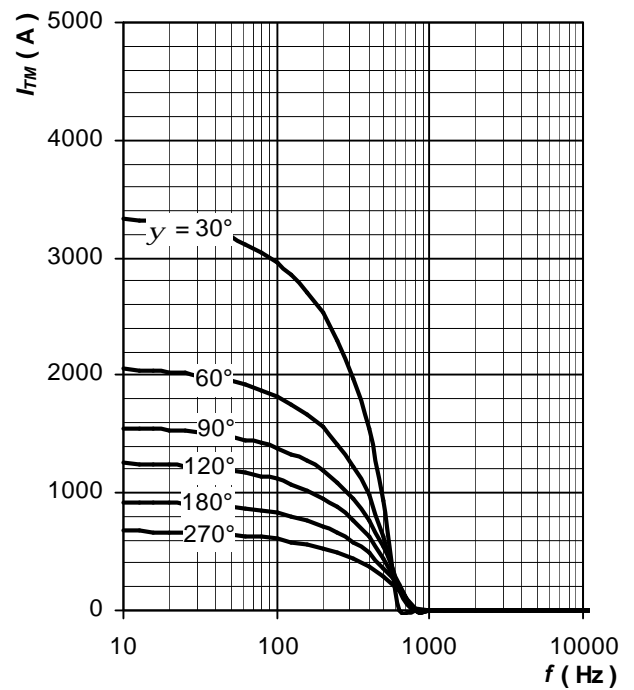

Fig. 34 Maximum on-state current vs. frequency, trapezoid waveform, $T_C = 90\text{ }^\circ\text{C}$, $di_T/dt = \pm 500\text{ A}/\mu\text{s}$, $V_R = 100\text{ V}$

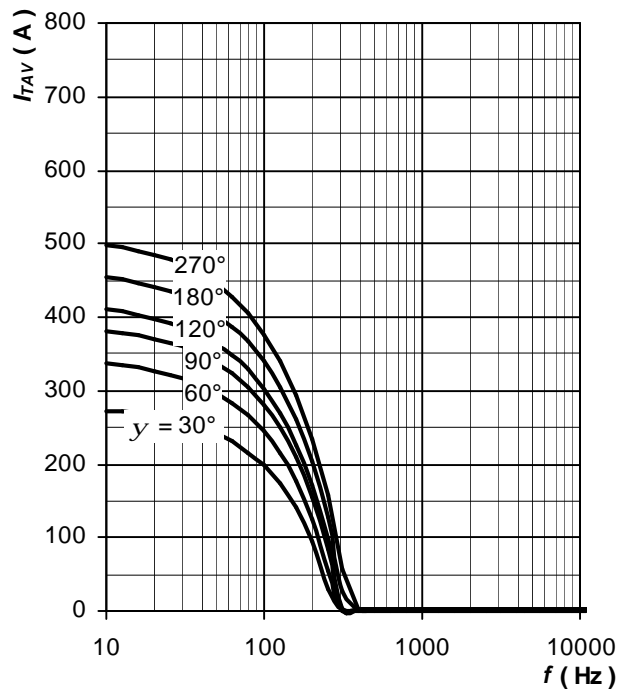

Fig. 35 Average on-state current vs. frequency, trapezoid waveform, $T_C = 90\text{ }^\circ\text{C}$, $di_T/dt = \pm 500\text{ A}/\mu\text{s}$, $V_R = 2/3 V_{DRM}$

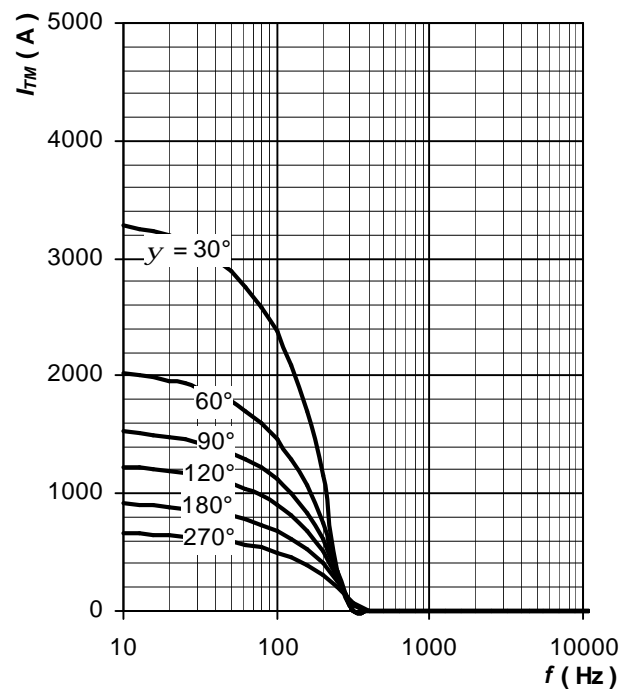

Fig. 36 Maximum on-state current vs. frequency, trapezoid waveform, $T_C = 90\text{ }^\circ\text{C}$, $di_T/dt = \pm 500\text{ A}/\mu\text{s}$, $V_R = 2/3 V_{DRM}$

Notes:

ABB s.r.o., Novodvorska 1768/138a, 142 21 Praha 4, Czech Republic

ABB s.r.o. reserves the right to change the data contained herein at any time without notice