

# 5SNA 1600N170300

## HiPak IGBT Module

$$V_{CE} = 1700 \text{ V}$$

$$I_C = 1600 \text{ A}$$

Ultra low-loss, rugged SPT+ chip-set  
 Smooth switching SPT+ chip-set for good EMC  
 AISiC base-plate for high power cycling capability  
 AlN substrate for low thermal resistance  
 Improved high reliability package  
 Recognized under UL1557, File E196689



### Maximum rated values <sup>1)</sup>

Parameter	Symbol	Conditions	min	max	Unit
Collector-emitter voltage	$V_{CES}$	$V_{GE} = 0 \text{ V}$ , $T_{vj} \geq 25 \text{ }^\circ\text{C}$		1700	V
DC collector current	$I_C$	$T_C = 70 \text{ }^\circ\text{C}$ , $T_{vj} = 150 \text{ }^\circ\text{C}$		1600	A
Peak collector current	$I_{CM}$	$t_p = 1 \text{ ms}$		3200	A
Gate-emitter voltage	$V_{GES}$		-20	20	V
Total power dissipation	$P_{tot}$	$T_C = 25 \text{ }^\circ\text{C}$ , $T_{vj} = 150 \text{ }^\circ\text{C}$		11900	W
DC forward current	$I_F$			1600	A
Peak forward current	$I_{FRM}$	$t_p = 1 \text{ ms}$		3200	A
Surge current	$I_{FSM}$	$V_R = 0 \text{ V}$ , $T_{vj} = 150 \text{ }^\circ\text{C}$ , $t_p = 10 \text{ ms}$ , half-sinewave		12000	A
IGBT short circuit SOA	$t_{psc}$	$V_{CC} = 1200 \text{ V}$ , $V_{CEM \text{ CHIP}} \leq 1700 \text{ V}$ $V_{GE} \leq 15 \text{ V}$ , $T_{vj \text{ start}} \leq 150 \text{ }^\circ\text{C}$		10	$\mu\text{s}$
Isolation voltage	$V_{ISOL}$	1 min, $f = 50 \text{ Hz}$		4000	V
Junction temperature	$T_{vj}$			175	$^\circ\text{C}$
Junction operating temperature	$T_{vj(op)}$		-50	150	$^\circ\text{C}$
Case temperature	$T_C$		-50	150	$^\circ\text{C}$
Storage temperature	$T_{stg}$		-50	125	$^\circ\text{C}$
Mounting torques <sup>2)</sup>	$M_s$	Base-heatsink, M6 screws	4	6	Nm
	$M_{t1}$	Main terminals, M8 screws	8	10	
	$M_{t2}$	Auxiliary terminals, M4 screws	2	3	

<sup>1)</sup> Maximum rated values indicate limits beyond which damage to the device may occur per IEC 60747

<sup>2)</sup> For detailed mounting instructions refer to Document No. 5SYA 2039

**IGBT characteristic values <sup>3)</sup>**

Parameter	Symbol	Conditions	min	typ	max	Unit	
Collector (-emitter) breakdown voltage	$V_{(BR)CES}$	$V_{GE} = 0 \text{ V}$ , $I_C = 10 \text{ mA}$ , $T_{vj} = 25 \text{ °C}$	1700			V	
Collector-emitter <sup>4)</sup> saturation voltage	$V_{CE \text{ sat}}$	$I_C = 1600 \text{ A}$ , $V_{GE} = 15 \text{ V}$	$T_{vj} = 25 \text{ °C}$	1.8	2.05	2.3	V
			$T_{vj} = 125 \text{ °C}$	2.15	2.4	2.65	V
			$T_{vj} = 150 \text{ °C}$		2.45		V
Collector cut-off current	$I_{CES}$	$V_{CE} = 1700 \text{ V}$ , $V_{GE} = 0 \text{ V}$	$T_{vj} = 25 \text{ °C}$		0.02	1	mA
			$T_{vj} = 125 \text{ °C}$		20	40	mA
			$T_{vj} = 150 \text{ °C}$		120		mA
Gate leakage current	$I_{GES}$	$V_{CE} = 0 \text{ V}$ , $V_{GE} = \pm 20 \text{ V}$ , $T_{vj} = 125 \text{ °C}$	-500		500	nA	
Gate-emitter threshold voltage	$V_{GE(TO)}$	$I_C = 160 \text{ mA}$ , $V_{CE} = V_{GE}$ , $T_{vj} = 25 \text{ °C}$	5.3		7.3	V	
Gate charge	$Q_{ge}$	$I_C = 1600 \text{ A}$ , $V_{CE} = 900 \text{ V}$ , $V_{GE} = -15 \text{ V} \dots 15 \text{ V}$		14		$\mu\text{C}$	
Internal gate resistance	$R_{Gint}$			0.8		$\Omega$	
Turn-on delay time	$t_{d(on)}$	$V_{CC} = 900 \text{ V}$ , $I_C = 1600 \text{ A}$ , $R_G = 0.9 \text{ }\Omega$ , $C_{GE} = 0 \text{ nF}$ , $V_{GE} = \pm 15 \text{ V}$ , $L_\sigma = 75 \text{ nH}$ , inductive load	$T_{vj} = 25 \text{ °C}$		570		ns
			$T_{vj} = 125 \text{ °C}$		630		ns
			$T_{vj} = 150 \text{ °C}$		650		ns
Rise time	$t_r$	$V_{CC} = 900 \text{ V}$ , $I_C = 1600 \text{ A}$ , $R_G = 0.9 \text{ }\Omega$ , $C_{GE} = 0 \text{ nF}$ , $V_{GE} = \pm 15 \text{ V}$ , $L_\sigma = 75 \text{ nH}$ , inductive load	$T_{vj} = 25 \text{ °C}$		250		ns
			$T_{vj} = 125 \text{ °C}$		260		ns
			$T_{vj} = 150 \text{ °C}$		260		ns
Turn-off delay time	$t_{d(off)}$	$V_{CC} = 900 \text{ V}$ , $I_C = 1600 \text{ A}$ , $R_G = 0.9 \text{ }\Omega$ , $C_{GE} = 0 \text{ nF}$ , $V_{GE} = \pm 15 \text{ V}$ , $L_\sigma = 75 \text{ nH}$ , inductive load	$T_{vj} = 25 \text{ °C}$		950		ns
			$T_{vj} = 125 \text{ °C}$		1060		ns
			$T_{vj} = 150 \text{ °C}$		1100		ns
Fall time	$t_f$	$V_{CC} = 900 \text{ V}$ , $I_C = 1600 \text{ A}$ , $R_G = 0.9 \text{ }\Omega$ , $C_{GE} = 0 \text{ nF}$ , $V_{GE} = \pm 15 \text{ V}$ , $L_\sigma = 75 \text{ nH}$ , inductive load	$T_{vj} = 25 \text{ °C}$		200		ns
			$T_{vj} = 125 \text{ °C}$		240		ns
			$T_{vj} = 150 \text{ °C}$		260		ns
Turn-on switching energy	$E_{on}$	$V_{CC} = 900 \text{ V}$ , $I_C = 1600 \text{ A}$ , $R_G = 0.9 \text{ }\Omega$ , $C_{GE} = 0 \text{ nF}$ , $V_{GE} = \pm 15 \text{ V}$ , $L_\sigma = 75 \text{ nH}$ , inductive load	$T_{vj} = 25 \text{ °C}$		430		mJ
			$T_{vj} = 125 \text{ °C}$		590		mJ
			$T_{vj} = 150 \text{ °C}$		650		mJ
Turn-off switching energy	$E_{off}$	$V_{CC} = 900 \text{ V}$ , $I_C = 1600 \text{ A}$ , $R_G = 0.9 \text{ }\Omega$ , $C_{GE} = 0 \text{ nF}$ , $V_{GE} = \pm 15 \text{ V}$ , $L_\sigma = 75 \text{ nH}$ , inductive load	$T_{vj} = 25 \text{ °C}$		420		mJ
			$T_{vj} = 125 \text{ °C}$		570		mJ
			$T_{vj} = 150 \text{ °C}$		640		mJ
Short circuit current	$I_{SC}$	$t_{psc} \leq 10 \text{ }\mu\text{s}$ , $V_{GE} = 15 \text{ V}$ , $V_{CC} = 1200 \text{ V}$ , $V_{CEM \text{ CHIP}} \leq 1700 \text{ V}$	$T_{vj} = 150 \text{ °C}$	6600		A	

<sup>3)</sup> Characteristic values according to IEC 60747 - 9

<sup>4)</sup> Collector-emitter saturation voltage is given at chip level

## Diode characteristic values <sup>5)</sup>

Parameter	Symbol	Conditions	min	typ	max	Unit	
Forward voltage <sup>6)</sup>	$V_F$	$I_F = 1600 \text{ A}$	$T_{vj} = 25 \text{ }^\circ\text{C}$	1.65	1.95	V	
			$T_{vj} = 125 \text{ }^\circ\text{C}$		1.67	2	V
			$T_{vj} = 150 \text{ }^\circ\text{C}$		1.6		V
Peak reverse recovery current	$I_{RM}$		$T_{vj} = 25 \text{ }^\circ\text{C}$	1190		A	
			$T_{vj} = 125 \text{ }^\circ\text{C}$	1400		A	
			$T_{vj} = 150 \text{ }^\circ\text{C}$	1490		A	
Recovered charge	$Q_{rr}$	$V_{CC} = 900 \text{ V},$ $I_F = 1600 \text{ A},$ $V_{GE} = \pm 15 \text{ V},$ $R_G = 0.9 \text{ }^\Omega, C_{GE} = 0 \text{ nF},$ $L_\sigma = 75 \text{ nH},$ inductive load	$T_{vj} = 25 \text{ }^\circ\text{C}$	490		$\mu\text{C}$	
			$T_{vj} = 125 \text{ }^\circ\text{C}$	840		$\mu\text{C}$	
			$T_{vj} = 150 \text{ }^\circ\text{C}$	1000		$\mu\text{C}$	
Reverse recovery time	$t_{rr}$		$T_{vj} = 25 \text{ }^\circ\text{C}$	720		ns	
			$T_{vj} = 125 \text{ }^\circ\text{C}$	1120		ns	
			$T_{vj} = 150 \text{ }^\circ\text{C}$	1220		ns	
Reverse recovery energy	$E_{rec}$		$T_{vj} = 25 \text{ }^\circ\text{C}$	310		mJ	
			$T_{vj} = 125 \text{ }^\circ\text{C}$	540		mJ	
			$T_{vj} = 150 \text{ }^\circ\text{C}$	640		mJ	

<sup>5)</sup> Characteristic values according to IEC 60747 - 15

<sup>6)</sup> Forward voltage is given at chip level

## Package properties <sup>7)</sup>

Parameter	Symbol	Conditions	min	typ	max	Unit
IGBT thermal resistance junction to case	$R_{th(j-c)IGBT}$				0.011	K/W
Diode thermal resistance junction to case	$R_{th(j-c)DIODE}$				0.018	K/W
IGBT thermal resistance <sup>2)</sup> case to heatsink	$R_{th(c-s)IGBT}$	IGBT per switch, $\lambda$ grease = $1\text{W/m} \times \text{K}$		0.012		K/W
Diode thermal resistance <sup>2)</sup> case to heatsink	$R_{th(c-s)DIODE}$	Diode per switch, $\lambda$ grease = $1\text{W/m} \times \text{K}$		0.024		K/W
Comparative tracking index	CTI		600			
Module stray inductance	$L_{\sigma CE}$			12		nH
Resistance, terminal-chip	$R_{CC'+EE'}$		$T_C = 25 \text{ }^\circ\text{C}$	0.082		m $\Omega$
			$T_C = 125 \text{ }^\circ\text{C}$	0.113		
			$T_C = 150 \text{ }^\circ\text{C}$	0.120		

<sup>2)</sup> For detailed mounting instructions refer to Document No. 5SYA 2039

## Mechanical properties <sup>7)</sup>

Parameter	Symbol	Conditions	min	typ	max	Unit
Dimensions	L x W x H	Typical		130 x 140 x 38		mm
Clearance distance in air	$d_a$	according to IEC 60664-1 and EN 50124-1	Term. to base:	19		mm
			Term. to term:	19		
Surface creepage distance	$d_s$	according to IEC 60664-1 and EN 50124-1	Term. to base:	28.2		mm
			Term. to term:	28.2		
Mass	m			820		g

<sup>7)</sup> Package and mechanical properties according to IEC 60747 - 15

## Electrical configuration

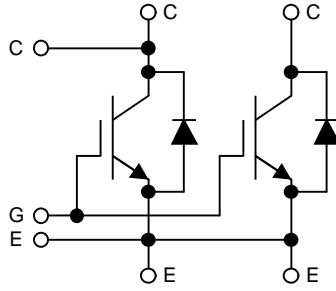

## Outline drawing <sup>2)</sup>

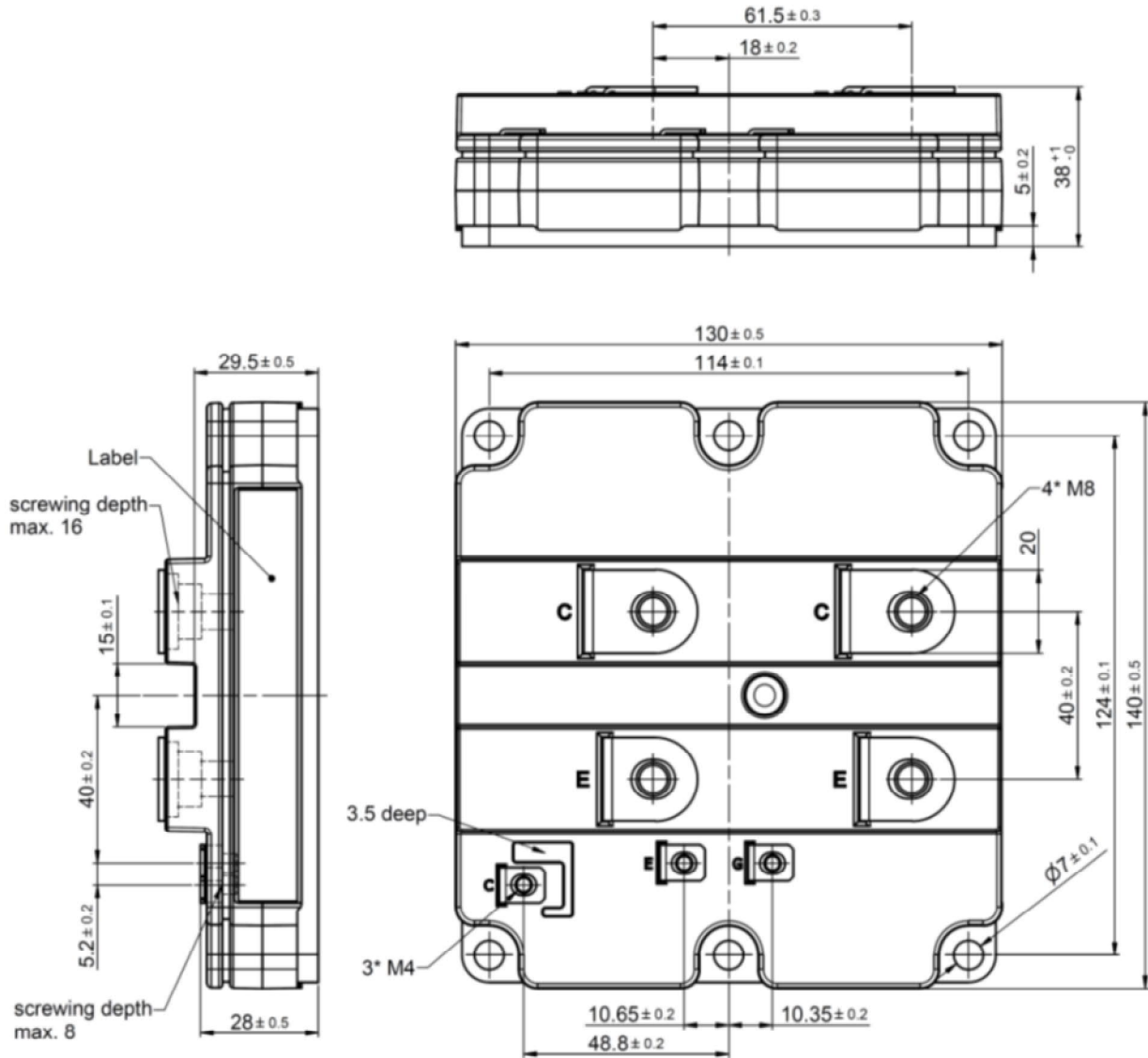

Note: all dimensions are shown in millimeters

<sup>2)</sup> For detailed mounting instructions refer to Document No. 5SYA 2039

This is an electrostatic sensitive device, please observe the international standard IEC 60747-1, chap. VIII.  
This product has been designed and qualified for Industrial Level.

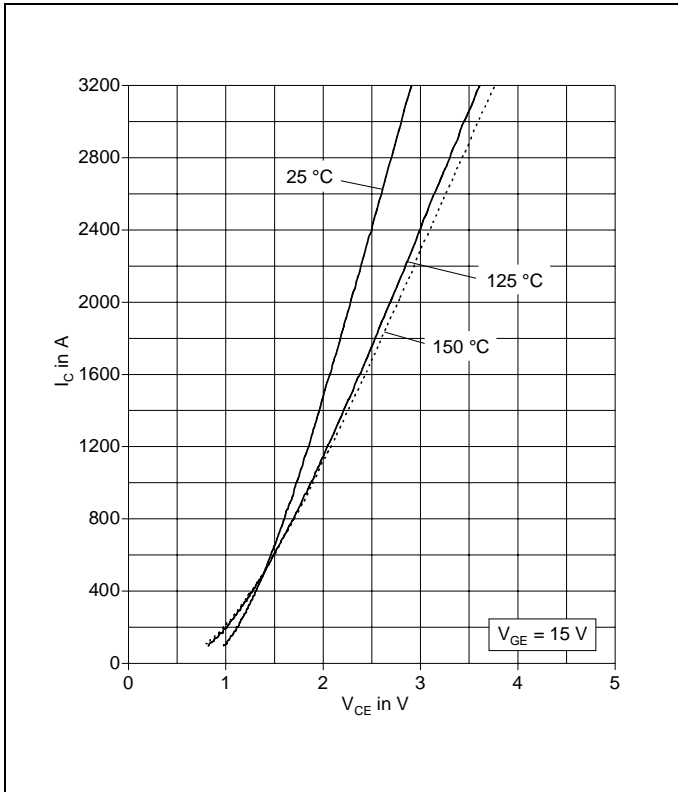

Fig. 1 Typical on-state characteristics, chip level

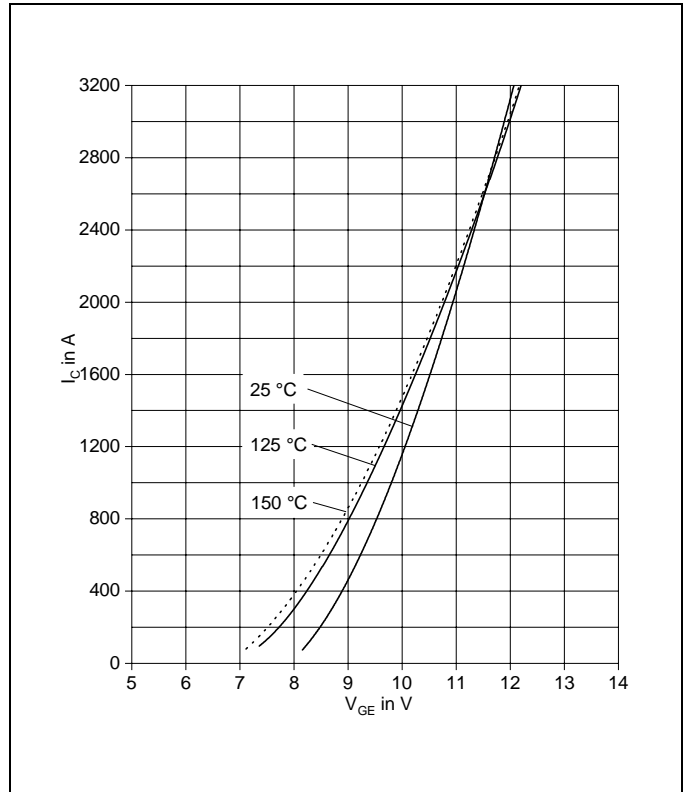

Fig. 2 Typical transfer characteristics, chip level

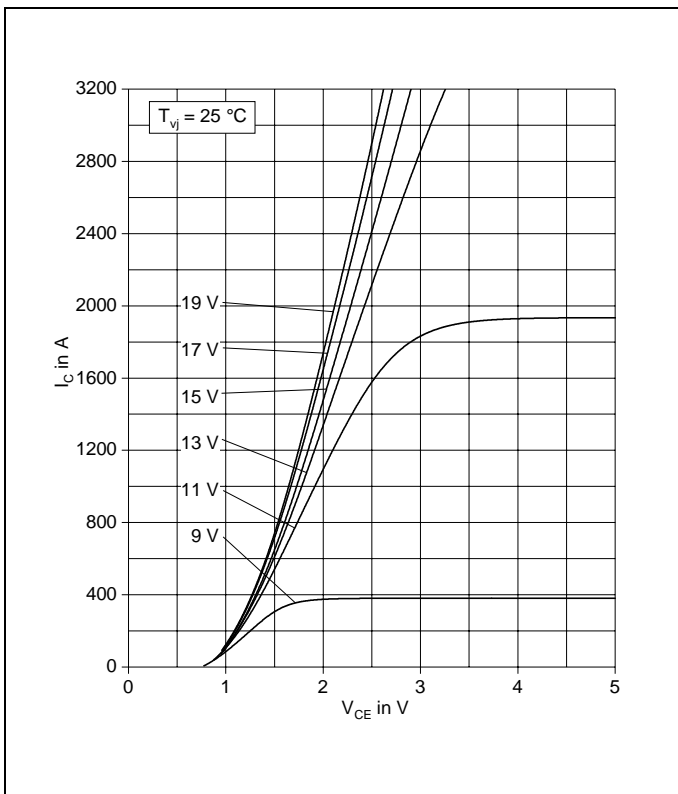

Fig. 3 Typical output characteristics, chip level

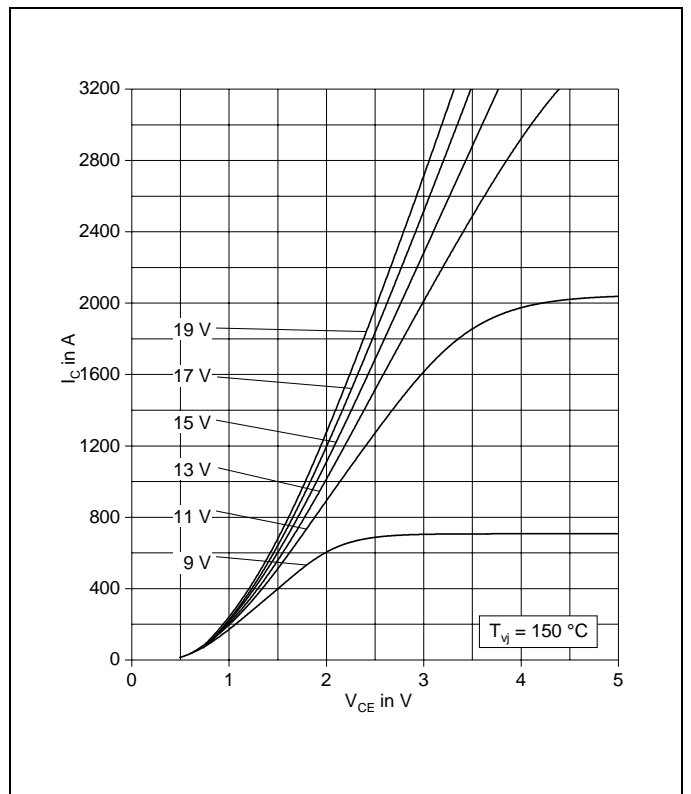

Fig. 4 Typical output characteristics, chip level

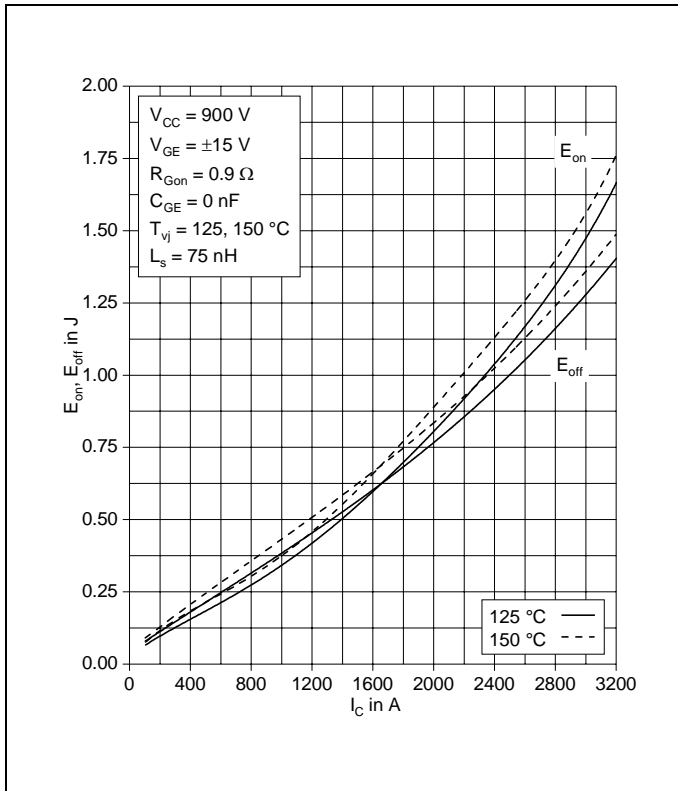

Fig. 5 Typical switching energies per pulse vs. collector current

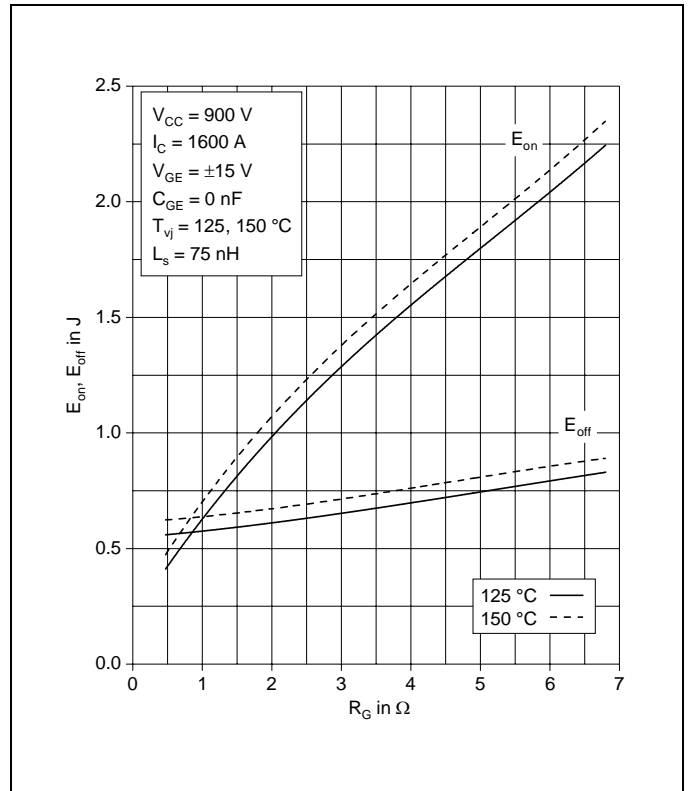

Fig. 6 Typical switching energies per pulse vs. gate resistor

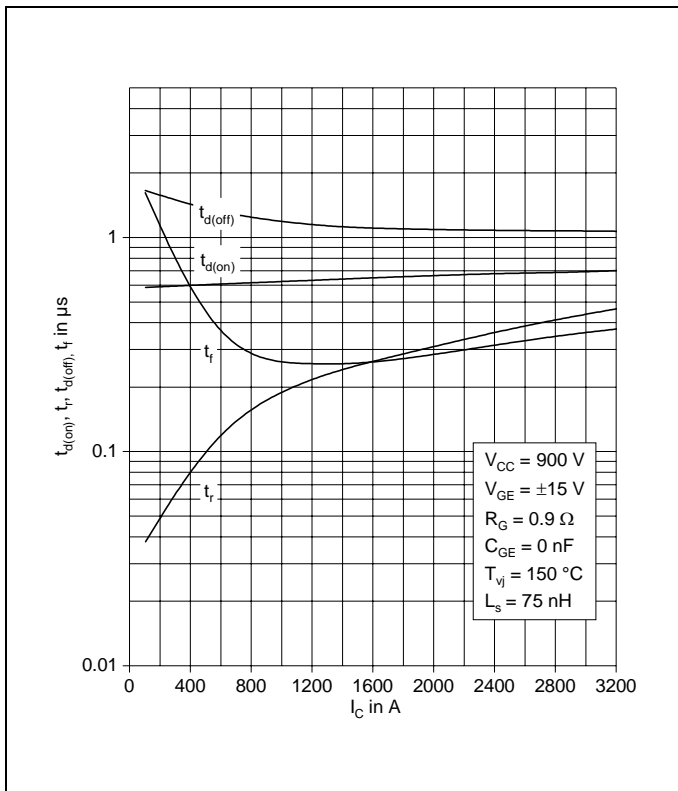

Fig. 7 Typical switching times vs. collector current

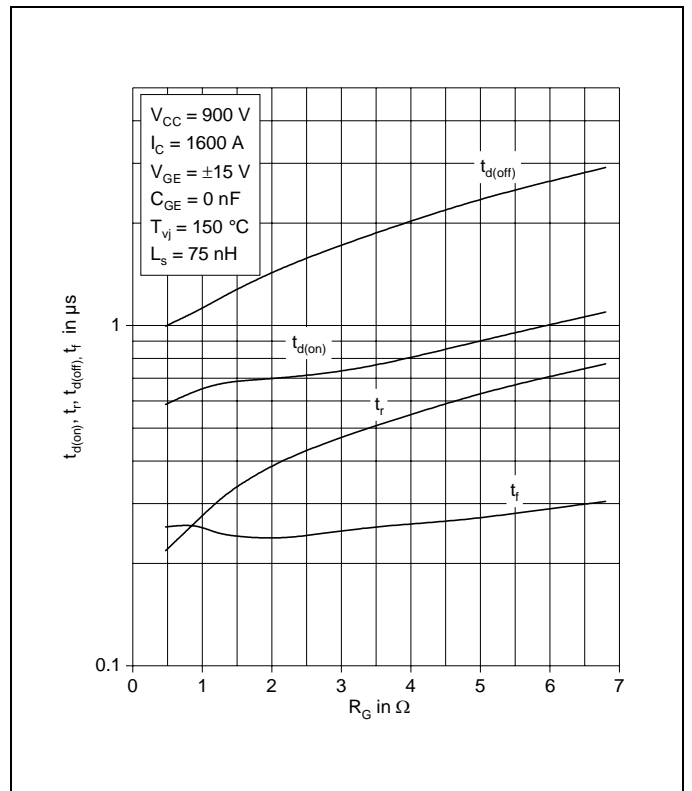

Fig. 8 Typical switching times vs. gate resistor

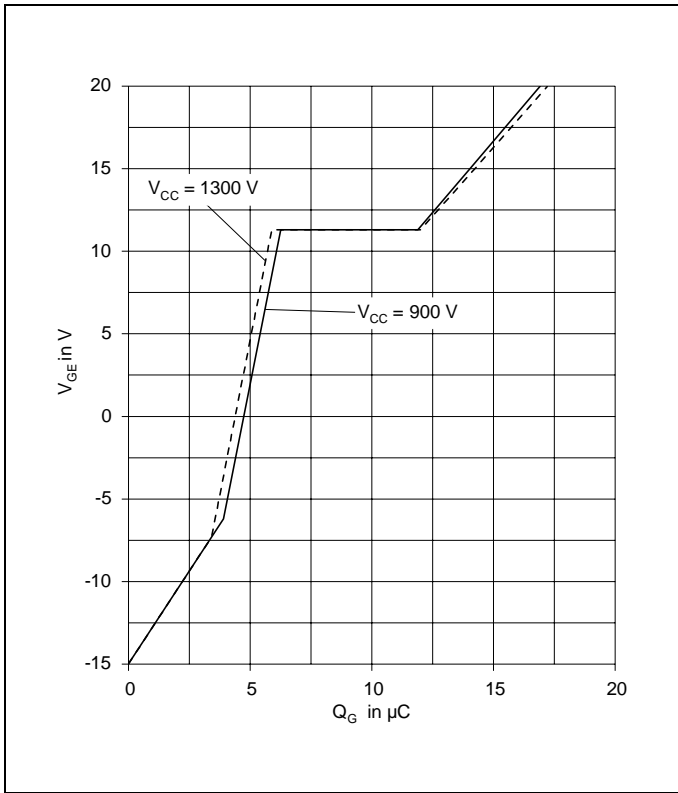

Fig. 9 Typical gate charge characteristics

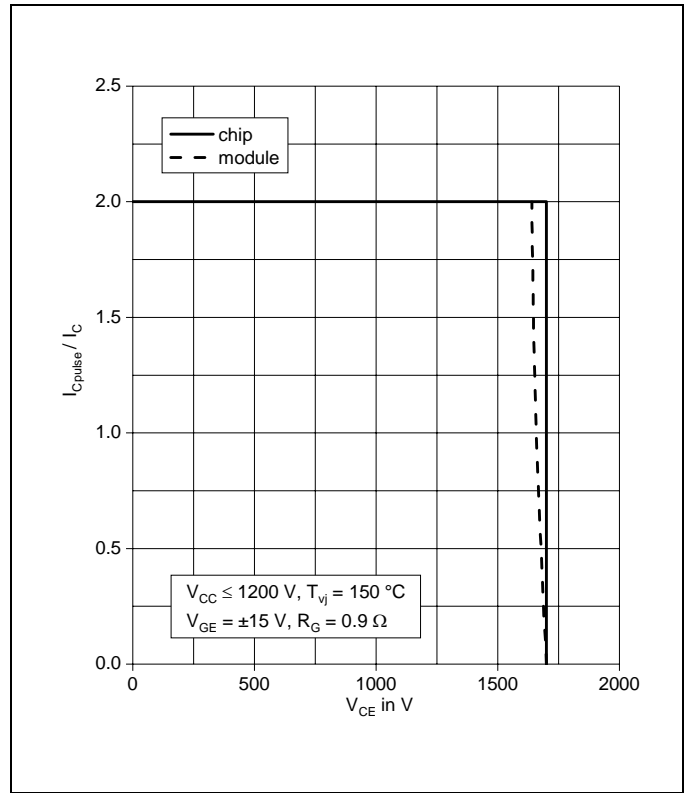

Fig. 10 Turn-off safe operating area (RBSOA)

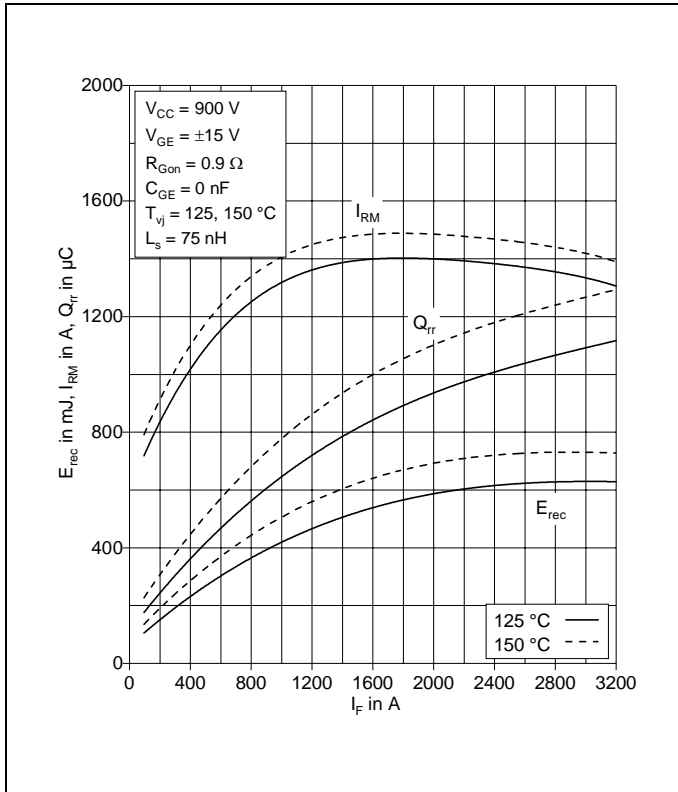

Fig. 11 Typical reverse recovery characteristics vs. forward current

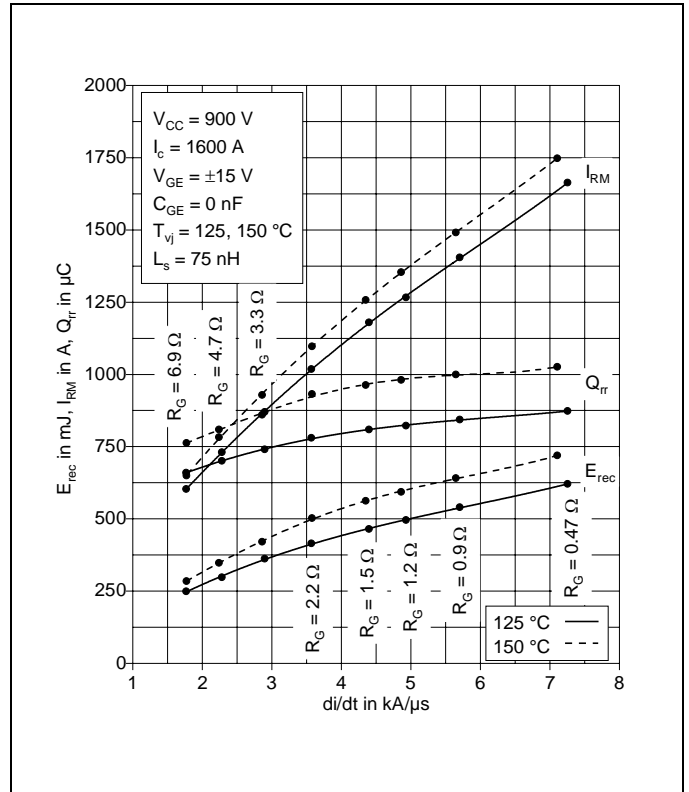

Fig. 12 Typical reverse recovery characteristics vs.  $di/dt$

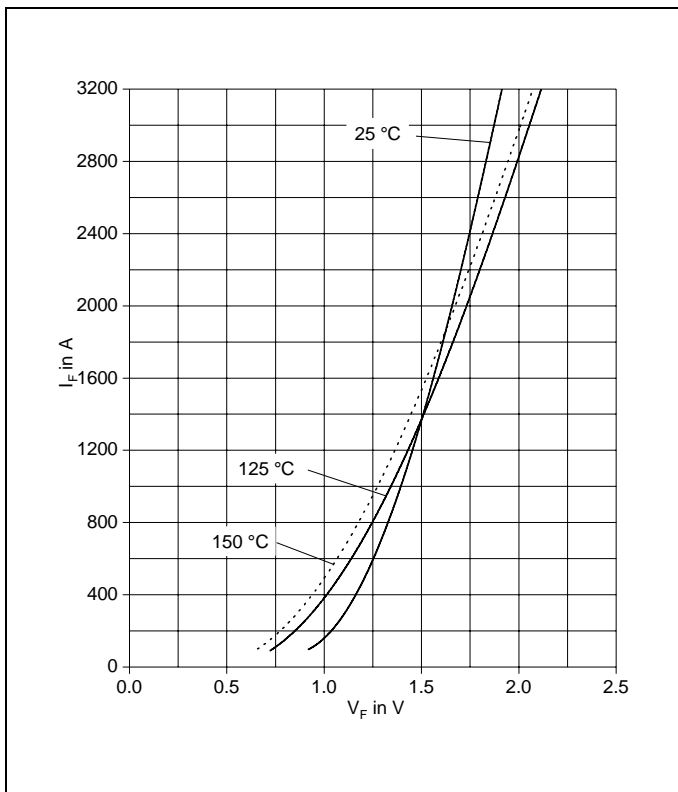

Fig. 13 Typical diode forward characteristics chip level

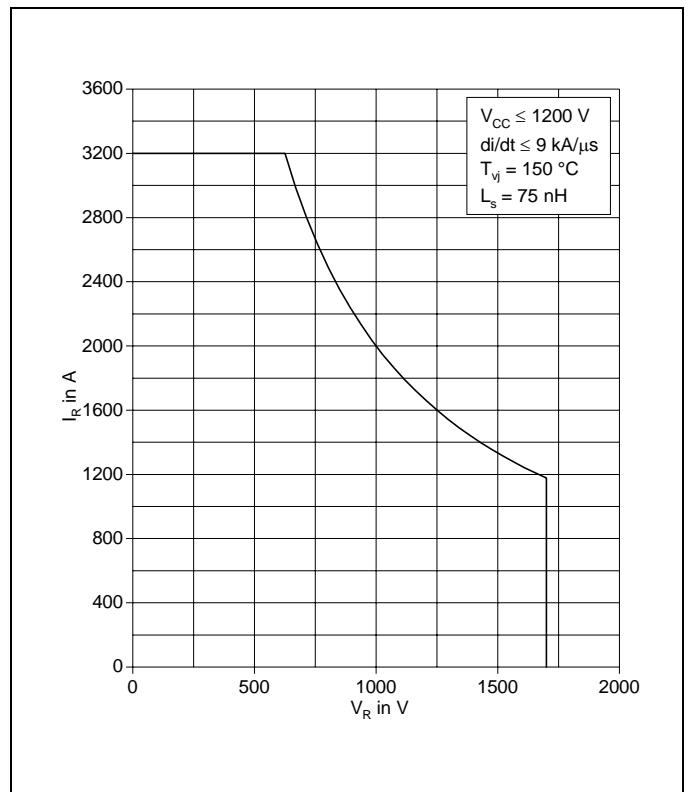

Fig. 14 Safe operating area diode (SOA)



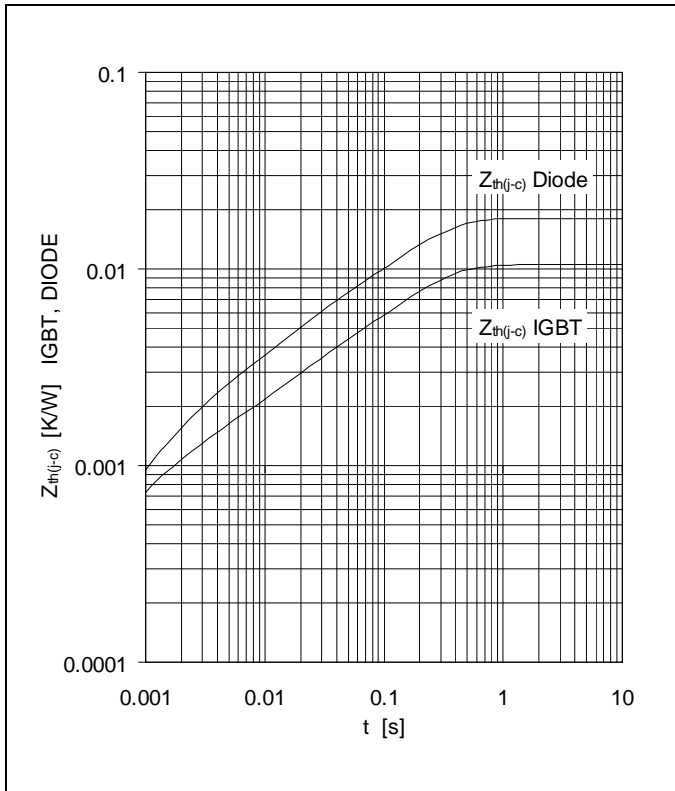

Fig. 15 Thermal impedance vs. time

Analytical function for transient thermal impedance:

$$Z_{th(j-c)}(t) = \sum_{i=1}^n R_i (1 - e^{-t/\tau_i})$$

	i	1	2	3	4	5
IGBT	Ri(K/kW)	7.59	1.8	0.743	0.369	
	$\tau_i$ (ms)	202	20.3	2.01	0.52	
DIODE	Ri(K/kW)	12.6	2.89	1.3	1.26	
	$\tau_i$ (ms)	210	29.6	7.01	1.49	

**Related documents:**

- 5SYA 2042 Failure rates of HiPak modules due to cosmic rays
- 5SYA 2043 Load - cycle capability of HiPaks
- 5SYA 2045 Thermal runaway during blocking
- 5SYA 2053 Applying IGBT
- 5SYA 2057 IGBT diode safe operating area (SOA)
- 5SYA 2058 Surge currents for IGBT diodes
- 5SYA 2093 Thermal design of IGBT modules
- 5SYA 2098 Paralleling of IGBT modules
- 5SYA 2039 Mounting Instructions for HiPak modules
- 5SZK 9111 Specification of environmental class for HiPak Storage
- 5SZK 9112 Specification of environmental class for HiPak Transportation
- 5SZK 9113 Specification of environmental class for HiPak Operation (Industry)
- 5SZK 9120 Specification of environmental class for HiPak

We reserve all rights in this document and in the subject matter and illustrations contained therein. Any reproduction, disclosure to third parties or utilization of its contents – in whole or in parts – is forbidden without prior written consent. Copyright 2020 Hitachi Powergrids. All rights reserved.

ABB Power Grids Switzerland Ltd, Semiconductors  
 A Hitachi ABB Joint Venture  
 Fabrikstrasse 3  
 CH-5600 Lenzburg  
 Switzerland  
[www.hitachiabb-powergrids.com/semiconductors](http://www.hitachiabb-powergrids.com/semiconductors)