

$V_{CE} = 6500 \text{ V}$
 $I_C = 600 \text{ A}$

ABB HiPak™

IGBT Module
5SNA 0600G650100

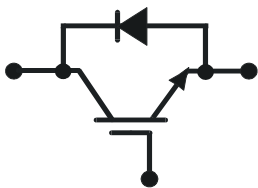

Doc. No. 5SYA1558-05 11-2015

- Low-loss, rugged SPT chip-set
- Smooth switching SPT chip-set for good EMC
- High insulation package
- AlSiC base-plate for high power cycling capability
- AlN substrate for low thermal resistance
- Improved high reliability package
- Recognized under UL1557, File E196689



Maximum rated values ¹⁾

Parameter	Symbol	Conditions	min	max	Unit
Collector-emitter voltage	V_{CES}	$V_{GE} = 0 \text{ V}, T_{vj} \geq 25 \text{ °C}$		6500	V
DC collector current	I_C	$T_c = 85 \text{ °C}$		600	A
Peak collector current	I_{CM}	$t_p = 1 \text{ ms}, T_c = 85 \text{ °C}$		1200	A
Gate-emitter voltage	V_{GES}		-20	20	V
Total power dissipation	P_{tot}	$T_c = 25 \text{ °C}, \text{ per switch (IGBT)}$		11900	W
DC forward current	I_F			600	A
Peak forward current	I_{FRM}			1200	A
Surge current	I_{FSM}	$V_R = 0 \text{ V}, T_{vj} = 125 \text{ °C},$ $t_p = 10 \text{ ms}, \text{ half-sinewave}$		6000	A
IGBT short circuit SOA	t_{psc}	$V_{CC} = 4400 \text{ V}, V_{CEMCHIP} \leq 6500 \text{ V}$ $V_{GE} \leq 15 \text{ V}, T_{vj} \leq 125 \text{ °C}$		10	μs
Isolation voltage	V_{isol}	$1 \text{ min}, f = 50 \text{ Hz}$		10200	V
Junction temperature	T_{vj}			150	$^{\circ}\text{C}$
Junction operating temperature	$T_{vj(op)}$		-50	125	$^{\circ}\text{C}$
Case temperature	T_c		-50	125	$^{\circ}\text{C}$
Storage temperature	T_{stg}		-50	125	$^{\circ}\text{C}$
Mounting torques ²⁾	M_s	Base-heatsink, M6 screws	4	6	Nm
	M_{t1}	Main terminals, M8 screws	8	10	
	M_{t2}	Auxiliary terminals, M4 screws	2	3	

¹⁾ Maximum rated values indicate limits beyond which damage to the device may occur per IEC 60747

²⁾ For detailed mounting instructions refer to ABB Document No. 5SYA2039

ABB Switzerland Ltd, Semiconductors reserves the right to change specifications without notice.



IGBT characteristic values ³⁾

Parameter	Symbol	Conditions	min	typ	max	Unit
Collector (-emitter) breakdown voltage	$V_{(BR)CES}$	$V_{GE} = 0 \text{ V}$, $I_C = 10 \text{ mA}$, $T_{vj} = 25 \text{ °C}$	6500			V
Collector-emitter ⁴⁾ saturation voltage	$V_{CE \text{ sat}}$	$I_C = 600 \text{ A}$, $V_{GE} = 15 \text{ V}$	$T_{vj} = 25 \text{ °C}$	4.2	4.8	V
			$T_{vj} = 125 \text{ °C}$	5.4	5.9	V
Collector cut-off current	I_{CES}	$V_{CE} = 6500 \text{ V}$, $V_{GE} = 0 \text{ V}$	$T_{vj} = 25 \text{ °C}$		12	mA
			$T_{vj} = 125 \text{ °C}$	70	120	mA
Gate leakage current	I_{GES}	$V_{CE} = 0 \text{ V}$, $V_{GE} = \pm 20 \text{ V}$, $T_{vj} = 125 \text{ °C}$	-500		500	nA
Gate-emitter threshold voltage	$V_{GE(TO)}$	$I_C = 240 \text{ mA}$, $V_{CE} = V_{GE}$, $T_{vj} = 25 \text{ °C}$	6.5	7.4	8.0	V
Gate charge	Q_{ge}	$I_C = 600 \text{ A}$, $V_{CE} = 3600 \text{ V}$, $V_{GE} = -15 \text{ V} .. 15 \text{ V}$		8.0		μC
Input capacitance	C_{ies}	$V_{CE} = 25 \text{ V}$, $V_{GE} = 0 \text{ V}$, $f = 1 \text{ MHz}$, $T_{vj} = 25 \text{ °C}$		143		nF
Output capacitance	C_{oes}			6.62		
Reverse transfer capacitance	C_{res}			1.27		
Internal gate resistance	R_{Gint}			0.54		Ω
Turn-on delay time	$t_{d(on)}$	$V_{CC} = 3600 \text{ V}$, $I_C = 600 \text{ A}$, $R_G = 3.9 \text{ }\Omega$,	$T_{vj} = 25 \text{ °C}$	640		ns
			$T_{vj} = 125 \text{ °C}$	570		
Rise time	t_r	$V_{GE} = \pm 15 \text{ V}$, $L_\sigma = 280 \text{ nH}$, inductive load	$T_{vj} = 25 \text{ °C}$	270		ns
			$T_{vj} = 125 \text{ °C}$	240		
Turn-off delay time	$t_{d(off)}$	$V_{CC} = 3600 \text{ V}$, $I_C = 600 \text{ A}$, $R_G = 3.9 \text{ }\Omega$,	$T_{vj} = 25 \text{ °C}$	1540		ns
			$T_{vj} = 125 \text{ °C}$	1860		
Fall time	t_f	$V_{GE} = \pm 15 \text{ V}$, $L_\sigma = 280 \text{ nH}$, inductive load	$T_{vj} = 25 \text{ °C}$	620		ns
			$T_{vj} = 125 \text{ °C}$	960		
Turn-on switching energy	E_{on}	$V_{CC} = 3600 \text{ V}$, $I_C = 600 \text{ A}$, $V_{GE} = \pm 15 \text{ V}$, $R_G = 3.9 \text{ }\Omega$, $L_\sigma = 280 \text{ nH}$, inductive load	$T_{vj} = 25 \text{ °C}$	3800		mJ
			$T_{vj} = 125 \text{ °C}$	4900		
Turn-off switching energy	E_{off}	$V_{CC} = 3600 \text{ V}$, $I_C = 600 \text{ A}$, $V_{GE} = \pm 15 \text{ V}$, $R_G = 3.9 \text{ }\Omega$, $L_\sigma = 280 \text{ nH}$, inductive load	$T_{vj} = 25 \text{ °C}$	1950		mJ
			$T_{vj} = 125 \text{ °C}$	3150		
Short circuit current	I_{SC}	$t_{psc} \leq 10 \text{ }\mu\text{s}$, $V_{GE} = 15 \text{ V}$, $T_{vj} = 125 \text{ °C}$, $V_{CC} = 4400 \text{ V}$, $V_{CEM \text{ CHIP}} \leq 6500 \text{ V}$		2700		A
Module stray inductance	$L_{\sigma \text{ CE}}$			18		nH
Resistance, terminal-chip	$R_{CC+EE'}$		$T_C = 25 \text{ °C}$	0.07		m Ω
			$T_C = 125 \text{ °C}$	0.1		

³⁾ Characteristic values according to IEC 60747 – 9⁴⁾ Collector-emitter saturation voltage is given at chip level

Diode characteristic values ⁵⁾

Parameter	Symbol	Conditions	min	typ	max	Unit
Forward voltage ⁶⁾	V_F	$I_F = 600 \text{ A}$	$T_{vj} = 25 \text{ °C}$	3.2	3.8	V
			$T_{vj} = 125 \text{ °C}$	3.4	4.0	
Reverse recovery current	I_{rr}		$T_{vj} = 25 \text{ °C}$	790		A
			$T_{vj} = 125 \text{ °C}$	990		
Recovered charge	Q_{rr}	$V_{CC} = 3600 \text{ V}$, $I_F = 600 \text{ A}$, $V_{GE} = \pm 15 \text{ V}$, $R_G = 3.9 \text{ } \Omega$	$T_{vj} = 25 \text{ °C}$	700		μC
			$T_{vj} = 125 \text{ °C}$	1200		
Reverse recovery time	t_{rr}	$L_\sigma = 280 \text{ nH}$ inductive load	$T_{vj} = 25 \text{ °C}$	1700		ns
			$T_{vj} = 125 \text{ °C}$	2200		
Reverse recovery energy	E_{rec}		$T_{vj} = 25 \text{ °C}$	1100		mJ
			$T_{vj} = 125 \text{ °C}$	2200		

⁵⁾ Characteristic values according to IEC 60747 – 2

⁶⁾ Forward voltage is given at chip level

Package properties ⁷⁾

Parameter	Symbol	Conditions	min	typ	max	Unit
IGBT thermal resistance junction to case	$R_{th(j-c)IGBT}$				0.011	K/W
Diode thermal resistance junction to case	$R_{th(j-c)DIODE}$				0.021	K/W
Thermal resistance case ²⁾ to heatsink	$R_{th(c-s)}$	per module, λ grease = $1\text{W/m} \times \text{K}$		0.006		K/W
Partial discharge extinction voltage	V_e	$f = 50 \text{ Hz}$, $Q_{PD} \leq 10\text{pC}$ (acc. to IEC 61287)	5100			V
Comparative tracking index	CTI			≥ 600		

²⁾ For detailed mounting instructions refer to ABB Document No. 5SYA2039

Mechanical properties ⁷⁾

Parameter	Symbol	Conditions	min	typ	max	Unit
Dimensions	$L \times W \times H$	Typical , see outline drawing	190 x 140 x 48			mm
Clearance distance in air	d_a	according to IEC 60664-1 and EN 50124-1	Term. to base:	40		mm
			Term. to term:	26		
Surface creepage distance	d_s	according to IEC 60664-1 and EN 50124-1	Term. to base:	64		mm
			Term. to term:	56		
Mass	m			1550		g

⁷⁾ Package and mechanical properties according to IEC 60747 – 15

Electrical configuration

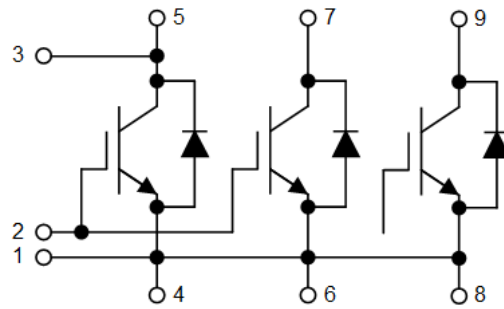

Outline drawing ²⁾

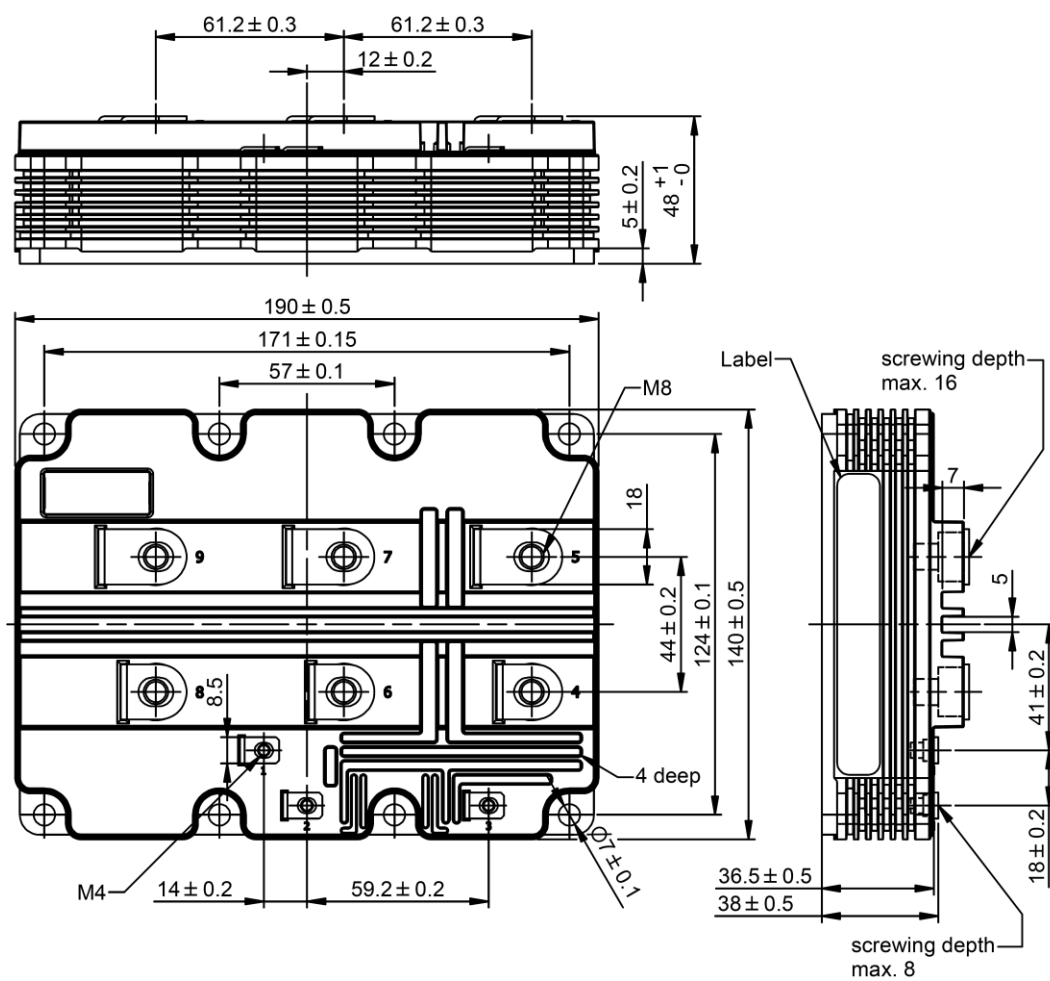

Note: all dimensions are shown in mm

²⁾ For detailed mounting instructions refer to ABB Document No. 5SYA2039

This is an electrostatic sensitive device, please observe the international standard IEC 60747-1, chap. IX.

This product has been designed and qualified for Industrial Level.

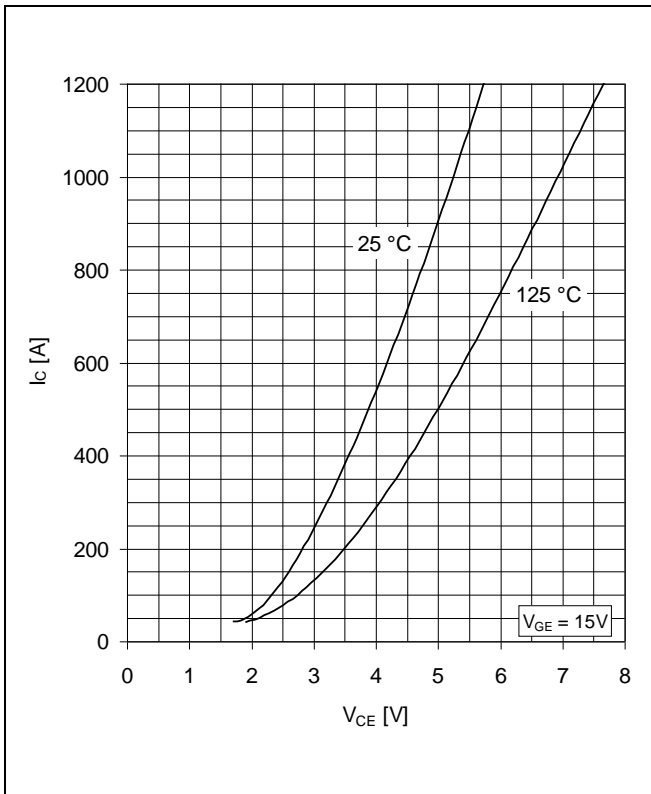

Fig. 1 Typical on-state characteristics, chip level

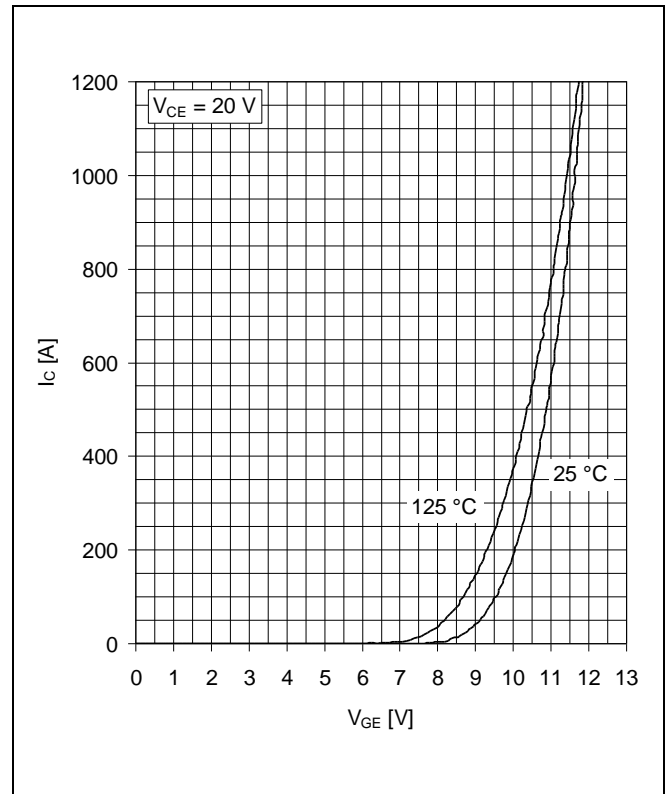

Fig. 2 Typical transfer characteristics, chip level

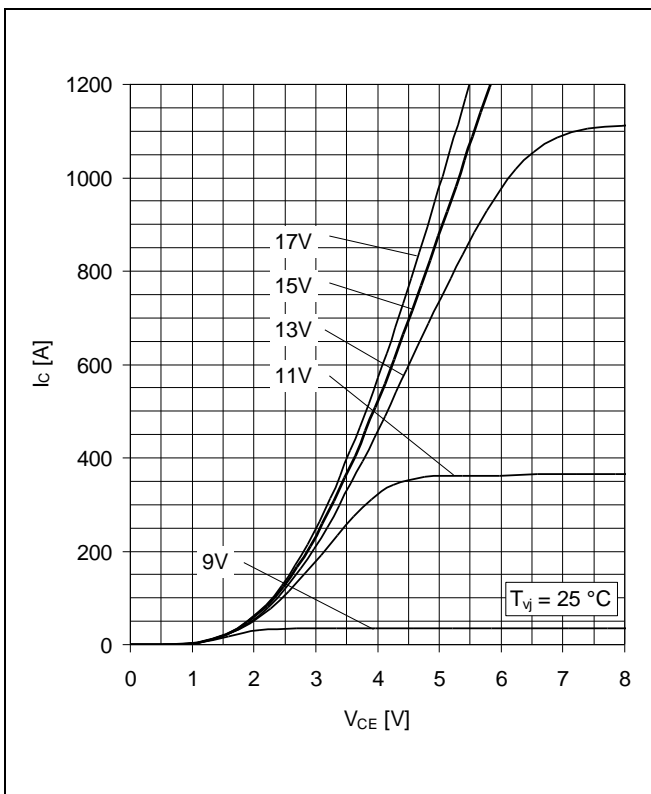

Fig. 3 Typical output characteristics, chip level

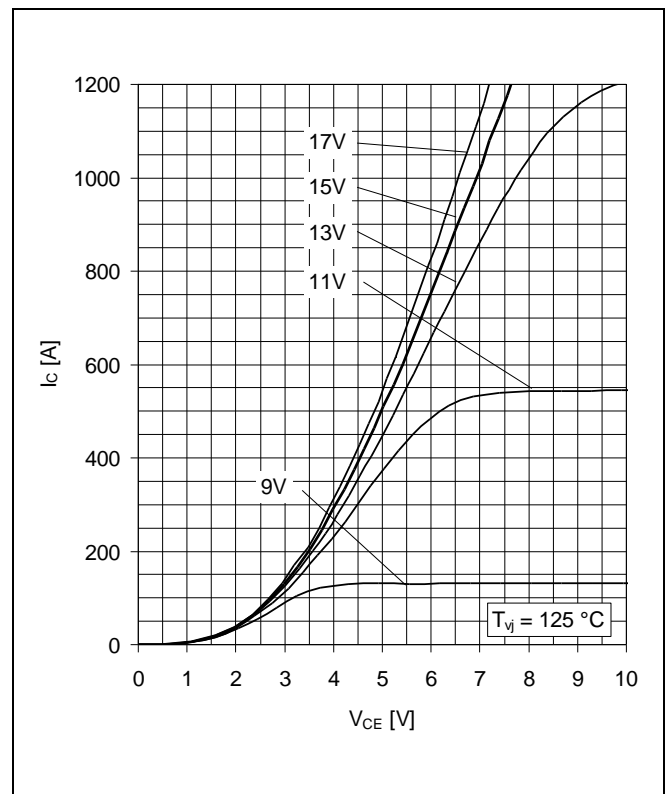

Fig. 4 Typical output characteristics, chip level

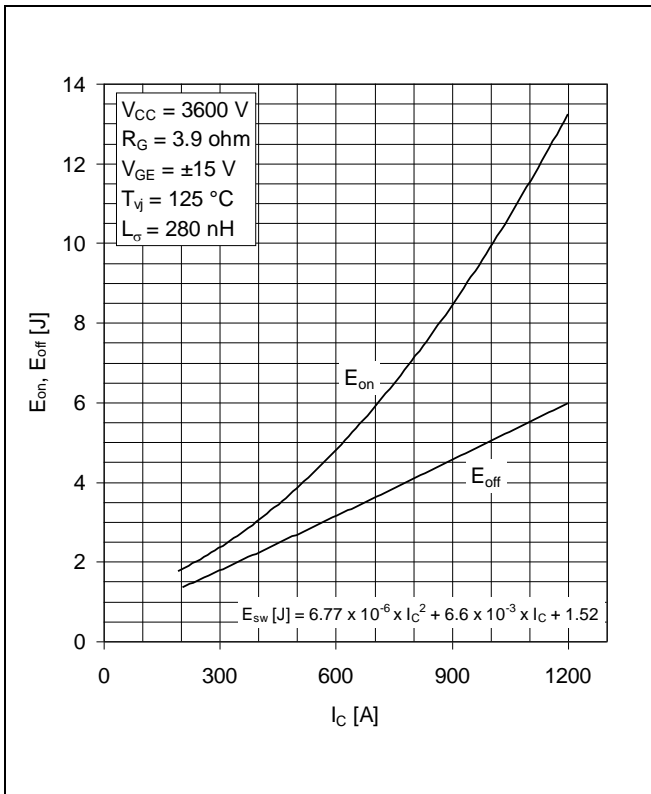

Fig. 5 Typical switching energies per pulse vs collector current

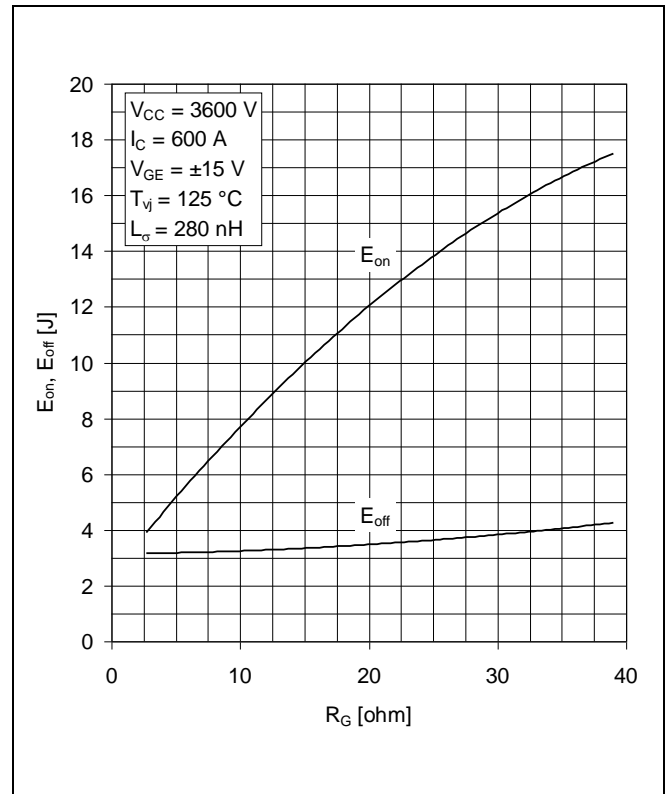

Fig. 6 Typical switching energies per pulse vs gate resistor

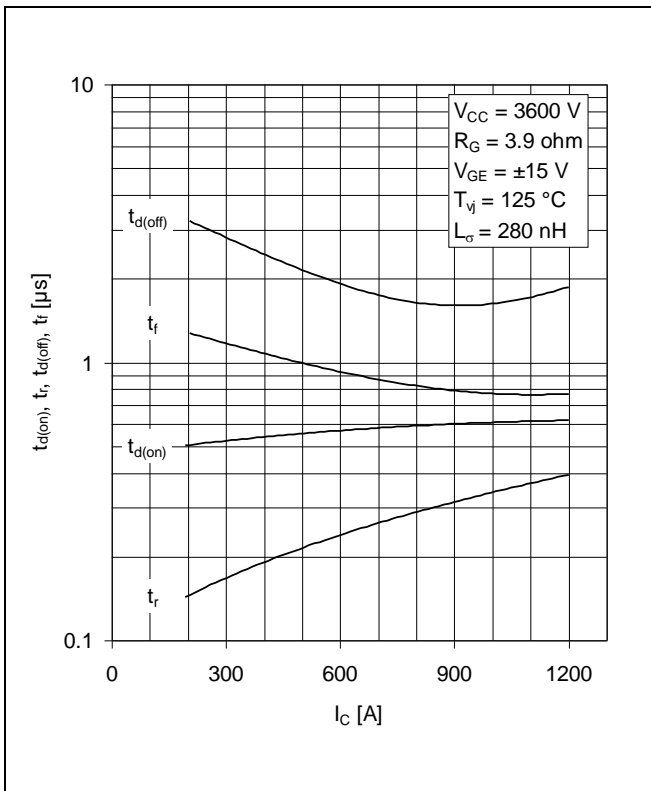

Fig. 7 Typical switching times vs collector current

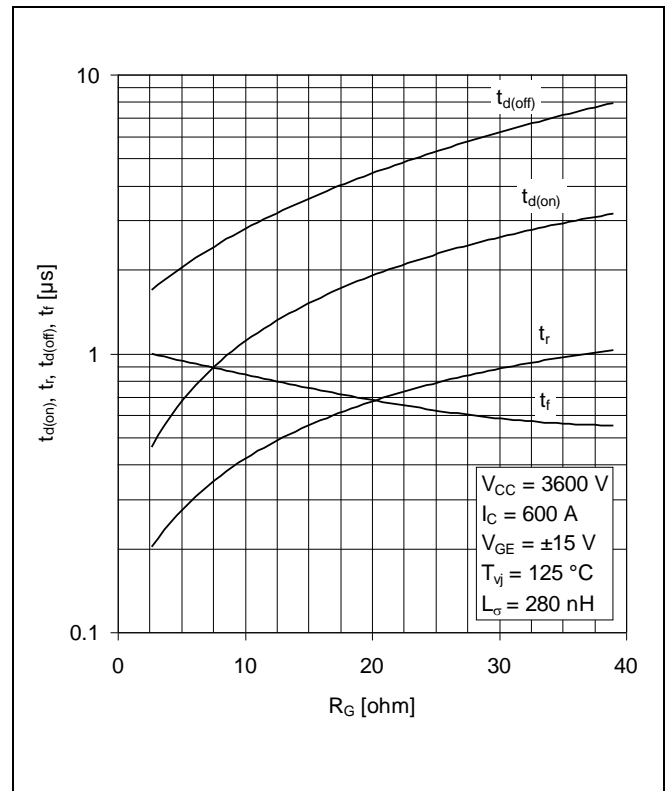

Fig. 8 Typical switching times vs gate resistor

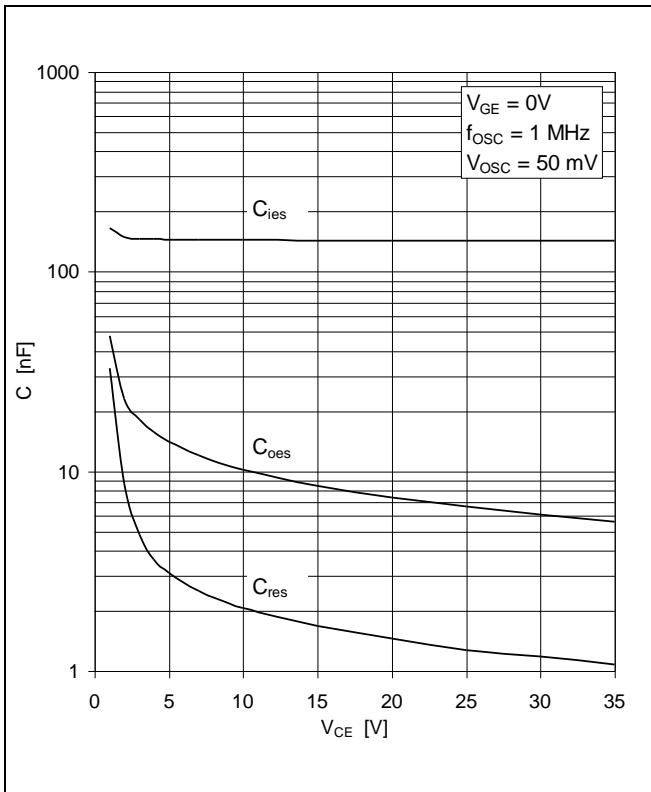

Fig. 9 Typical capacitances vs collector-emitter voltage

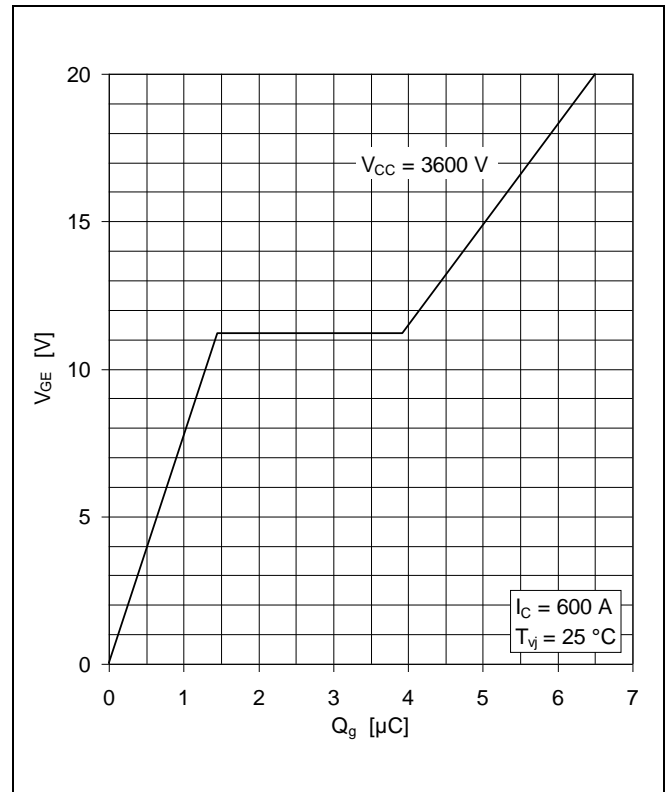

Fig. 10 Typical gate charge characteristics

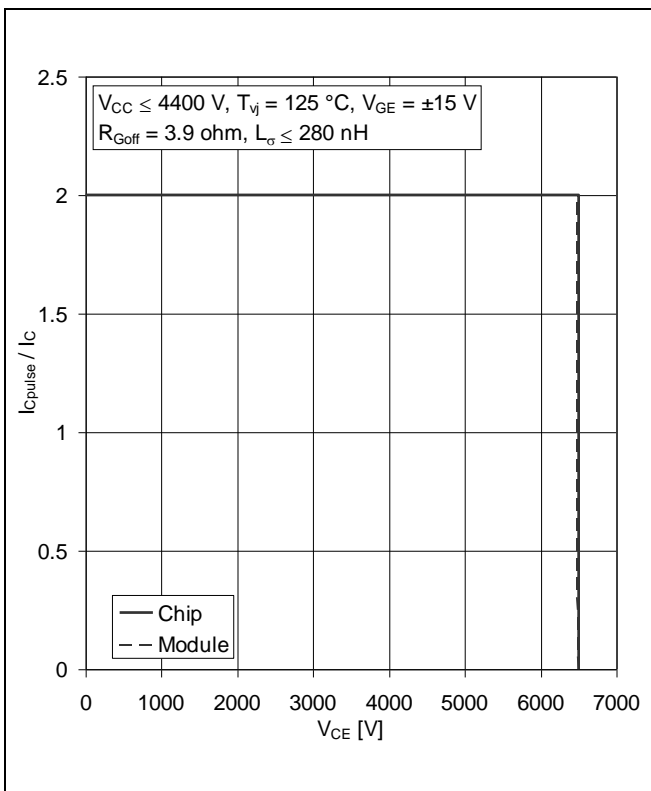

Fig. 11 Turn-off safe operating area (RBSOA)

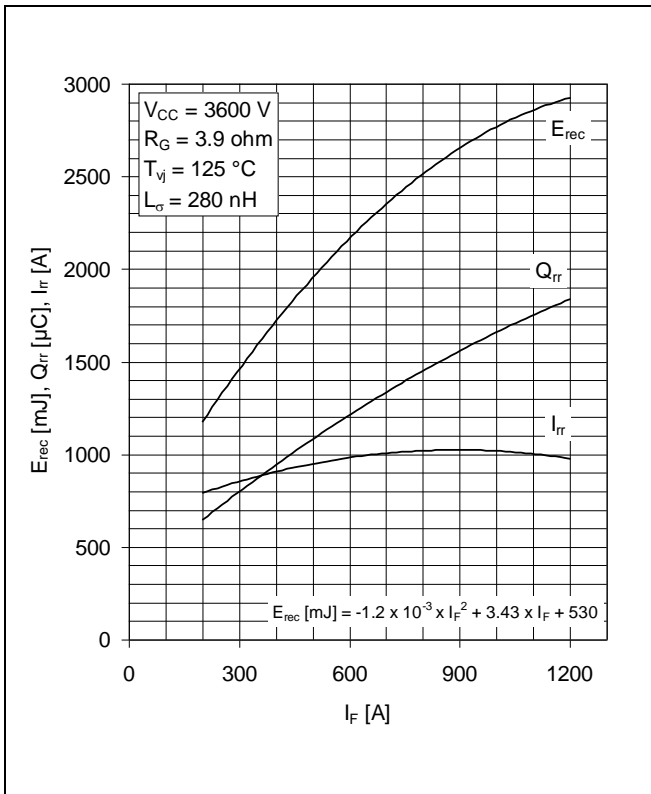

Fig. 12 Typical reverse recovery characteristics vs forward current

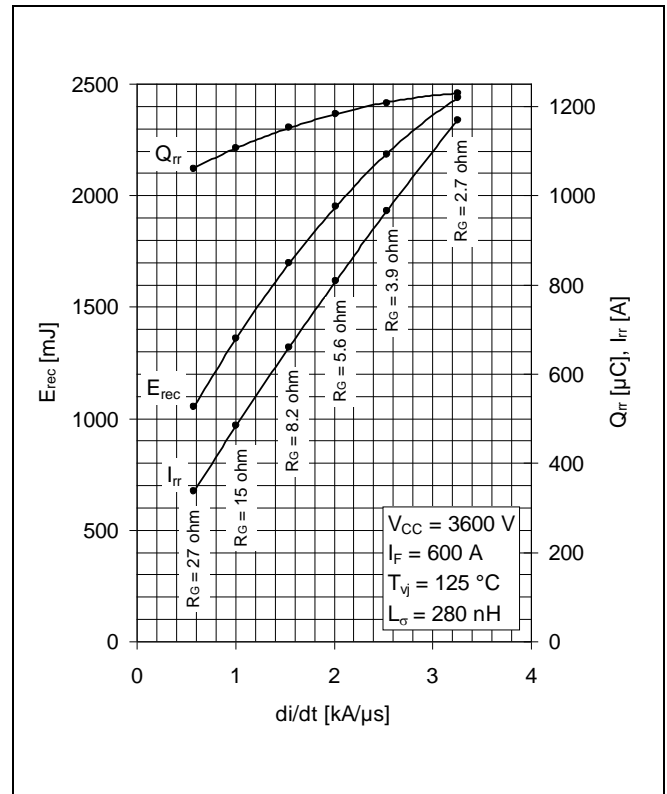

Fig. 13 Typical reverse recovery characteristics vs di/dt

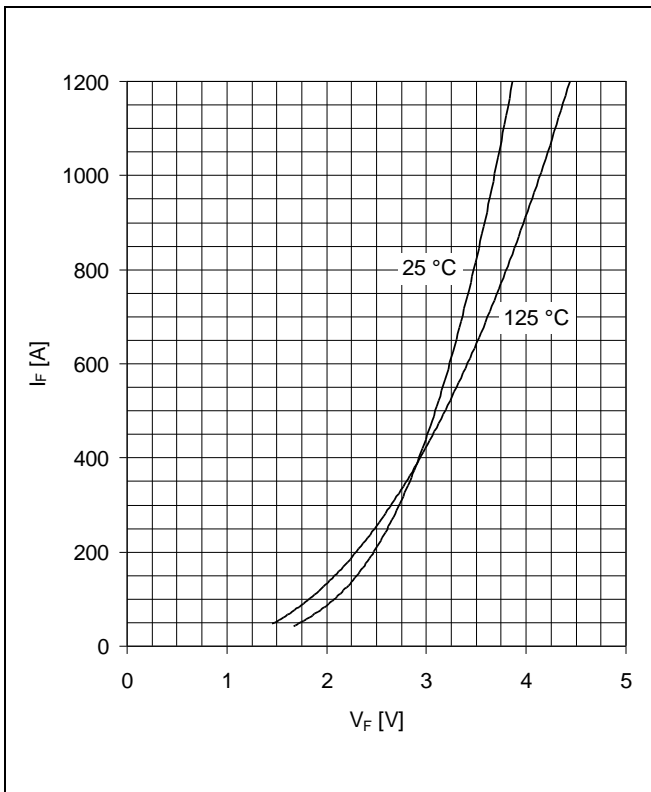

Fig. 14 Typical diode forward characteristics, chip level

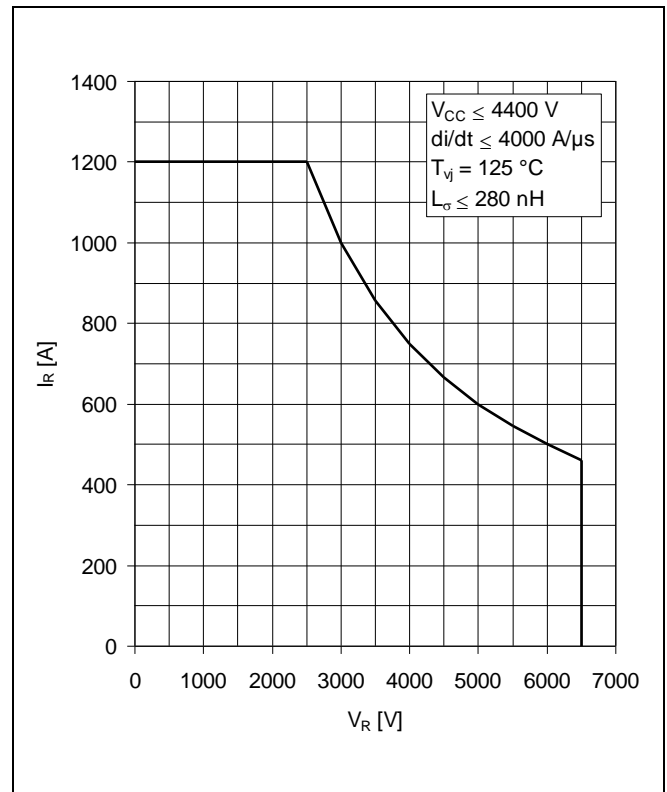

Fig. 15 Safe operating area diode (SOA)

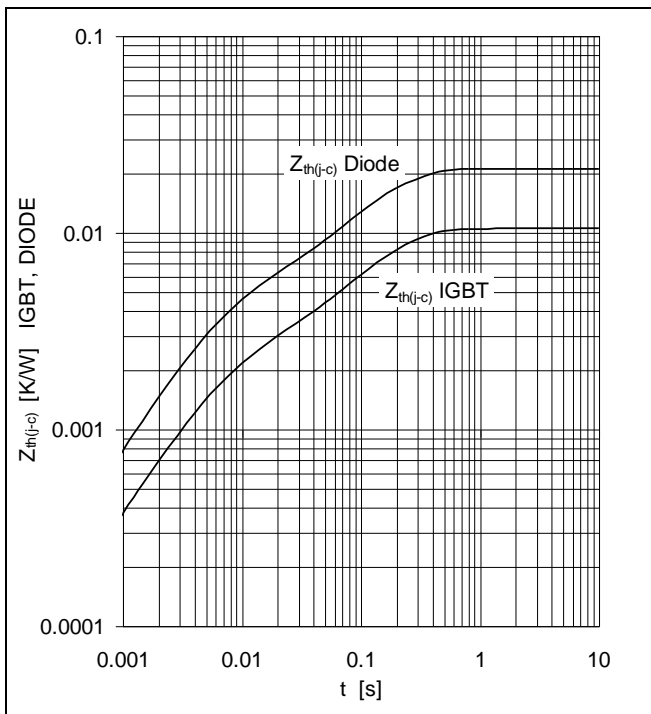

Fig. 16 Thermal impedance vs time

Analytical function for transient thermal impedance:

$$Z_{th(j-c)}(t) = \sum_{i=1}^n R_i (1 - e^{-t/\tau_i})$$

	i	1	2	3	4	5
IGBT	R _i (K/kW)	8.5	2			
	τ _i (ms)	151	5.84			
DIODE	R _i (K/kW)	17	4.2			
	τ _i (ms)	144	5.83			

Related documents:

- 5SYA 2042 Failure rates of HiPak modules due to cosmic rays
- 5SYA 2043 Load – cycle capability of HiPaks
- 5SYA 2045 Thermal runaway during blocking
- 5SYA 2053 Applying IGBT
- 5SYA 2058 Surge currents for IGBT diodes
- 5SYA 2093 Thermal design of IGBT modules
- 5SYA 2098 Paralleling of IGBT modules
- 5SZK 9111 Specification of environmental class for HiPak Storage
- 5SZK 9112 Specification of environmental class for HiPak Transportation
- 5SZK 9113 Specification of environmental class for HiPak Operation (Industry)
- 5SZK 9120 Specification of environmental class for HiPak

We reserve the right to make technical changes or to modify the contents of this document without prior notice.

We reserve all rights in this document and the information contained therein. Any reproduction or utilization of this document or parts thereof for commercial purposes without our prior written consent is forbidden.

Any liability for use of our products contrary to the instructions in this document is excluded.



ABB Switzerland Ltd
Semiconductors
 Fabrikstrasse 3
 CH-5600 Lenzburg, Switzerland

Telephone +41 (0)58 586 1419
 Fax +41 (0)58 586 1306
 Email abbsem@ch.abb.com
 Internet www.abb.com/semiconductors