

$V_{CE} = 6500 \text{ V}$   
 $I_C = 400 \text{ A}$

**ABB HiPak™**

**IGBT Module**  
**5SNA 0400J650100**

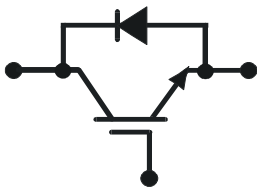

Doc. No. 5SYA 1592-01 Jun 07

- Low-loss, rugged SPT chip-set
- Smooth switching SPT chip-set for good EMC
- High insulation package
- AISiC base-plate for high power cycling capability
- AlN substrate for low thermal resistance



**Maximum rated values <sup>1)</sup>**

Parameter	Symbol	Conditions	min	max	Unit
Collector-emitter voltage	$V_{CES}$	$V_{GE} = 0 \text{ V}, T_{vj} \geq 25 \text{ °C}$		6500	V
DC collector current	$I_C$	$T_c = 85 \text{ °C}$		400	A
Peak collector current	$I_{CM}$	$t_p = 1 \text{ ms}, T_c = 85 \text{ °C}$		800	A
Gate-emitter voltage	$V_{GES}$		-20	20	V
Total power dissipation	$P_{tot}$	$T_c = 25 \text{ °C}$ , per switch (IGBT)		7350	W
DC forward current	$I_F$			400	A
Peak forward current	$I_{FRM}$			800	A
Surge current	$I_{FSM}$	$V_R = 0 \text{ V}, T_{vj} = 125 \text{ °C}$ , $t_p = 10 \text{ ms}$ , half-sinewave		4000	A
IGBT short circuit SOA	$t_{psc}$	$V_{CC} = 4400 \text{ V}, V_{CEMCHIP} \leq 6500 \text{ V}$ $V_{GE} \leq 15 \text{ V}, T_{vj} \leq 125 \text{ °C}$		10	$\mu\text{s}$
Isolation voltage	$V_{isol}$	1 min, $f = 50 \text{ Hz}$		10200	V
Junction temperature	$T_{vj}$			125	$^{\circ}\text{C}$
Junction operating temperature	$T_{vj(op)}$		-40	125	$^{\circ}\text{C}$
Case temperature	$T_c$		-40	125	$^{\circ}\text{C}$
Storage temperature	$T_{stg}$		-40	125	$^{\circ}\text{C}$
Mounting torques <sup>2)</sup>	$M_s$	Base-heatsink, M6 screws	4	6	Nm
	$M_{t1}$	Main terminals, M8 screws	8	10	
	$M_{t2}$	Auxiliary terminals, M4 screws	2	3	

<sup>1)</sup> Maximum rated values indicate limits beyond which damage to the device may occur per IEC 60747

<sup>2)</sup> For detailed mounting instructions refer to ABB Document No. 5SYA2039

**ABB Switzerland Ltd, Semiconductors reserves the right to change specifications without notice.**



IGBT characteristic values <sup>3)</sup>

Parameter	Symbol	Conditions	min	typ	max	Unit
Collector (-emitter) breakdown voltage	$V_{(BR)CES}$	$V_{GE} = 0 \text{ V}$ , $I_C = 10 \text{ mA}$ , $T_{vj} = 25 \text{ °C}$	6500			V
Collector-emitter <sup>4)</sup> saturation voltage	$V_{CE \text{ sat}}$	$I_C = 400 \text{ A}$ , $V_{GE} = 15 \text{ V}$		4.2	4.8	V
		$T_{vj} = 25 \text{ °C}$				
		$T_{vj} = 125 \text{ °C}$		5.4	5.9	V
Collector cut-off current	$I_{CES}$	$V_{CE} = 6500 \text{ V}$ , $V_{GE} = 0 \text{ V}$			8	mA
		$T_{vj} = 25 \text{ °C}$				
		$T_{vj} = 125 \text{ °C}$		35	80	mA
Gate leakage current	$I_{GES}$	$V_{CE} = 0 \text{ V}$ , $V_{GE} = \pm 20 \text{ V}$ , $T_{vj} = 125 \text{ °C}$	-500		500	nA
Gate-emitter threshold voltage	$V_{GE(TO)}$	$I_C = 160 \text{ mA}$ , $V_{CE} = V_{GE}$ , $T_{vj} = 25 \text{ °C}$	6	7.4	8	V
Gate charge	$Q_{ge}$	$I_C = 400 \text{ A}$ , $V_{CE} = 3600 \text{ V}$ , $V_{GE} = -15 \text{ V} \dots 15 \text{ V}$		5.3		$\mu\text{C}$
Input capacitance	$C_{ies}$	$V_{CE} = 25 \text{ V}$ , $V_{GE} = 0 \text{ V}$ , $f = 1 \text{ MHz}$ , $T_{vj} = 25 \text{ °C}$		95.3		nF
Output capacitance	$C_{oes}$			4.41		
Reverse transfer capacitance	$C_{res}$			0.85		
Turn-on delay time	$t_{d(on)}$	$V_{CC} = 3600 \text{ V}$ , $I_C = 400 \text{ A}$ , $R_G = 5.6 \text{ }\Omega$ ,	$T_{vj} = 25 \text{ °C}$	700		ns
			$T_{vj} = 125 \text{ °C}$	630		
Rise time	$t_r$	$V_{GE} = \pm 15 \text{ V}$ , $L_\sigma = 280 \text{ nH}$ , inductive load	$T_{vj} = 25 \text{ °C}$	250		ns
			$T_{vj} = 125 \text{ °C}$	220		
Turn-off delay time	$t_{d(off)}$	$V_{CC} = 3600 \text{ V}$ , $I_C = 400 \text{ A}$ , $R_G = 5.6 \text{ }\Omega$ ,	$T_{vj} = 25 \text{ °C}$	1410		ns
			$T_{vj} = 125 \text{ °C}$	1700		
Fall time	$t_f$	$V_{GE} = \pm 15 \text{ V}$ , $L_\sigma = 280 \text{ nH}$ , inductive load	$T_{vj} = 25 \text{ °C}$	650		ns
			$T_{vj} = 125 \text{ °C}$	980		
Turn-on switching energy	$E_{on}$	$V_{CC} = 3600 \text{ V}$ , $I_C = 400 \text{ A}$ , $V_{GE} = \pm 15 \text{ V}$ , $R_G = 5.6 \text{ }\Omega$ , $L_\sigma = 280 \text{ nH}$ , inductive load	$T_{vj} = 25 \text{ °C}$	2250		mJ
			$T_{vj} = 125 \text{ °C}$	2800		
Turn-off switching energy	$E_{off}$	$V_{CC} = 3600 \text{ V}$ , $I_C = 400 \text{ A}$ , $V_{GE} = \pm 15 \text{ V}$ , $R_G = 5.6 \text{ }\Omega$ , $L_\sigma = 280 \text{ nH}$ , inductive load	$T_{vj} = 25 \text{ °C}$	1340		mJ
			$T_{vj} = 125 \text{ °C}$	2120		
Short circuit current	$I_{SC}$	$t_{psc} \leq 10 \text{ }\mu\text{s}$ , $V_{GE} = 15 \text{ V}$ , $T_{vj} = 125 \text{ °C}$ , $V_{CC} = 4400 \text{ V}$ , $V_{CEM \text{ CHIP}} \leq 6500 \text{ V}$		1800		A
Module stray inductance	$L_{\sigma \text{ CE}}$			20		nH
Resistance, terminal-chip	$R_{CC'+EE'}$		$T_C = 25 \text{ °C}$	0.1		m $\Omega$
			$T_C = 125 \text{ °C}$	0.15		

<sup>3)</sup> Characteristic values according to IEC 60747 – 9<sup>4)</sup> Collector-emitter saturation voltage is given at chip level

**Diode characteristic values**<sup>5)</sup>

Parameter	Symbol	Conditions	min	typ	max	Unit
Forward voltage <sup>6)</sup>	$V_F$	$I_F = 400 \text{ A}$	$T_{vj} = 25 \text{ °C}$	3.2	3.8	V
			$T_{vj} = 125 \text{ °C}$	3.4	4.0	
Reverse recovery current	$I_{rr}$	$V_{CC} = 3600 \text{ V},$ $I_F = 400 \text{ A},$ $V_{GE} = \pm 15 \text{ V},$ $R_G = 5.6 \text{ } \Omega$ $L_\sigma = 280 \text{ nH}$ inductive load	$T_{vj} = 25 \text{ °C}$	510		A
			$T_{vj} = 125 \text{ °C}$	680		
Recovered charge	$Q_{rr}$	$V_{CC} = 3600 \text{ V},$ $I_F = 400 \text{ A},$ $V_{GE} = \pm 15 \text{ V},$ $R_G = 5.6 \text{ } \Omega$ $L_\sigma = 280 \text{ nH}$ inductive load	$T_{vj} = 25 \text{ °C}$	450		$\mu\text{C}$
			$T_{vj} = 125 \text{ °C}$	770		
Reverse recovery time	$t_{rr}$	$V_{CC} = 3600 \text{ V},$ $I_F = 400 \text{ A},$ $V_{GE} = \pm 15 \text{ V},$ $R_G = 5.6 \text{ } \Omega$ $L_\sigma = 280 \text{ nH}$ inductive load	$T_{vj} = 25 \text{ °C}$	1840		ns
			$T_{vj} = 125 \text{ °C}$	2120		
Reverse recovery energy	$E_{rec}$	$V_{CC} = 3600 \text{ V},$ $I_F = 400 \text{ A},$ $V_{GE} = \pm 15 \text{ V},$ $R_G = 5.6 \text{ } \Omega$ $L_\sigma = 280 \text{ nH}$ inductive load	$T_{vj} = 25 \text{ °C}$	670		mJ
			$T_{vj} = 125 \text{ °C}$	1380		

<sup>5)</sup> Characteristic values according to IEC 60747 – 2<sup>6)</sup> Forward voltage is given at chip level**Package properties**<sup>7)</sup>

Parameter	Symbol	Conditions	min	typ	max	Unit
IGBT thermal resistance junction to case	$R_{th(j-c)IGBT}$				0.016	K/W
Diode thermal resistance junction to case	$R_{th(j-c)DIODE}$				0.032	K/W
IGBT thermal resistance <sup>2)</sup> case to heatsink	$R_{th(c-s)IGBT}$	IGBT per switch, $\lambda$ grease = $1\text{W}/\text{m}^2 \times \text{K}$		0.012		K/W
Diode thermal resistance <sup>7)</sup> case to heatsink	$R_{th(c-s)DIODE}$	Diode per switch, $\lambda$ grease = $1\text{W}/\text{m}^2 \times \text{K}$		0.024		K/W
Partial discharge extinction voltage	$V_e$	$f = 50 \text{ Hz}, Q_{PD} \leq 10\text{pC}$ (acc. to IEC 61287)	5100			V
Comparative tracking index	CTI			$\geq 600$		

<sup>2)</sup> For detailed mounting instructions refer to ABB Document No. 5SYA2039**Mechanical properties**<sup>7)</sup>

Parameter	Symbol	Conditions	min	typ	max	Unit
Dimensions	$L \times W \times H$	Typical, see outline drawing	130 × 140 × 48			mm
Clearance distance in air	$d_a$	according to IEC 60664-1 and EN 50124-1	Term. to base:	40		mm
			Term. to term:	26		
Surface creepage distance	$d_s$	according to IEC 60664-1 and EN 50124-1	Term. to base:	64		mm
			Term. to term:	56		
Mass	$m$			1150		g

<sup>7)</sup> Package and mechanical properties according to IEC 60747 – 15

## Electrical configuration

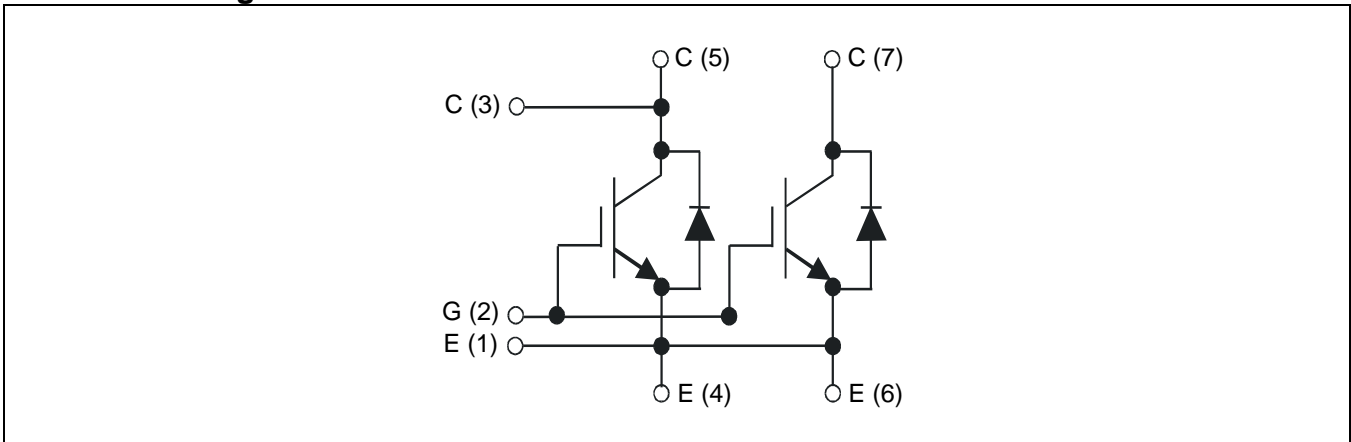

## Outline drawing <sup>2)</sup>

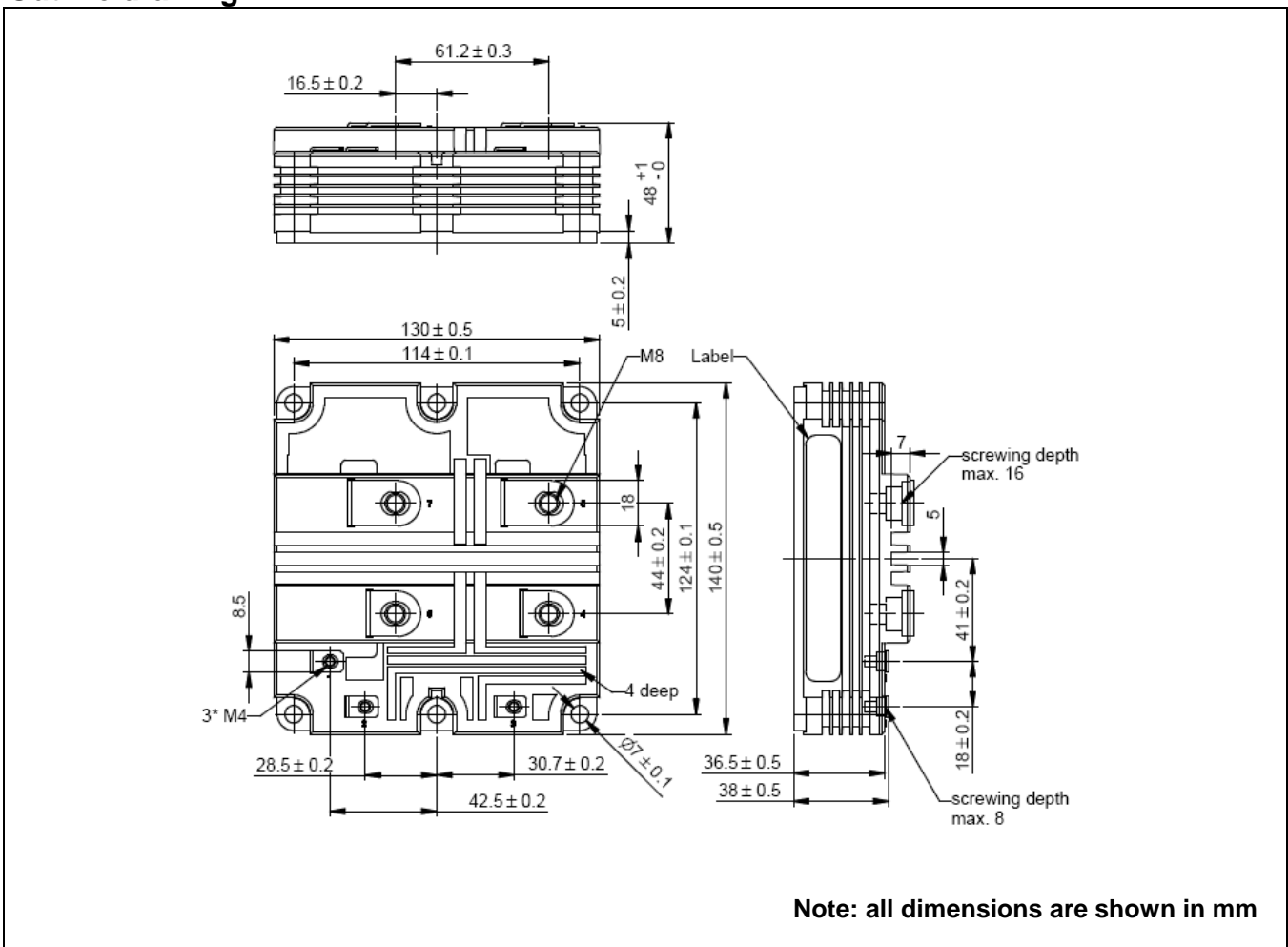

<sup>2)</sup> For detailed mounting instructions refer to ABB Document No. 5SYA2039

**This is an electrostatic sensitive device, please observe the international standard IEC 60747-1, chap. IX.**

**This product has been designed and qualified for Industrial Level.**

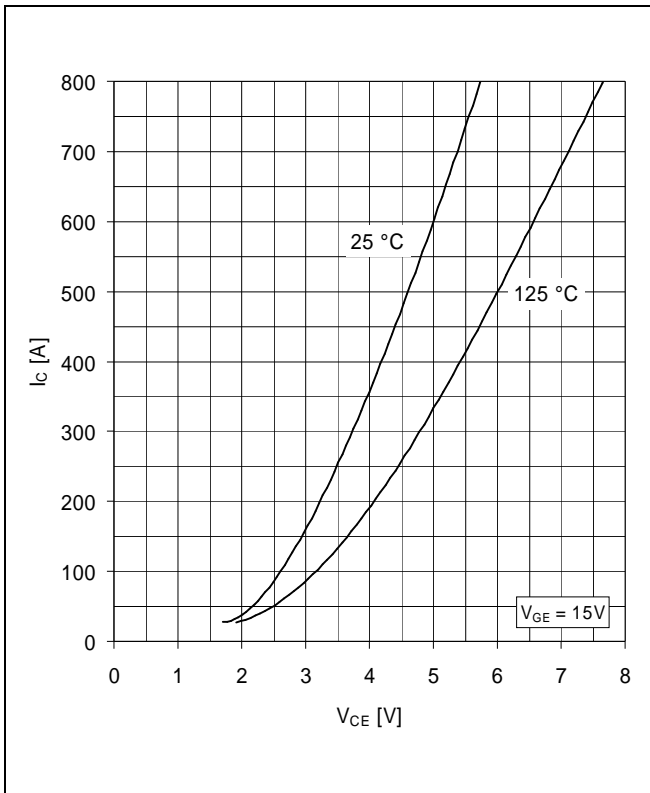

**Fig. 1** Typical on-state characteristics, chip level

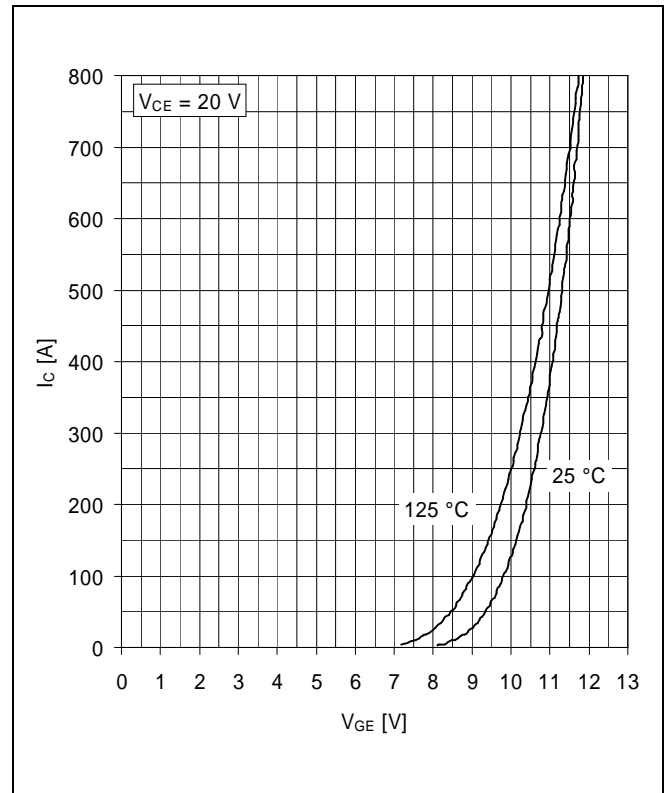

**Fig. 2** Typical transfer characteristics, chip level

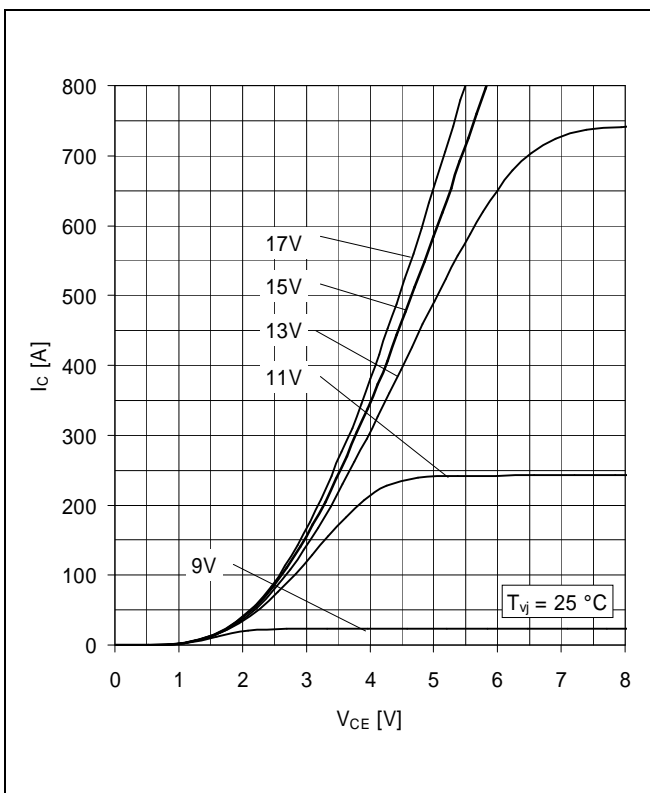

**Fig. 3** Typical output characteristics, chip level

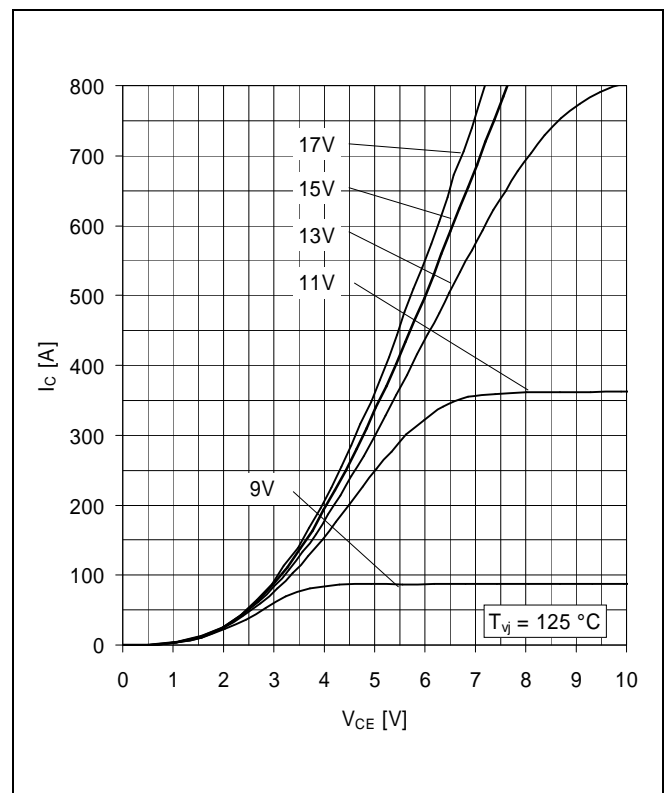

**Fig. 4** Typical output characteristics, chip level

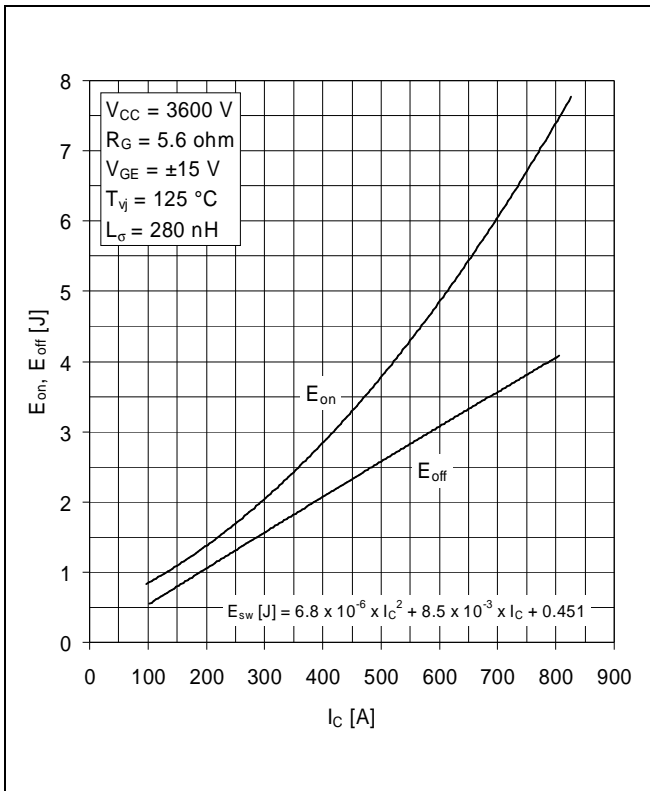

**Fig. 5** Typical switching energies per pulse vs collector current

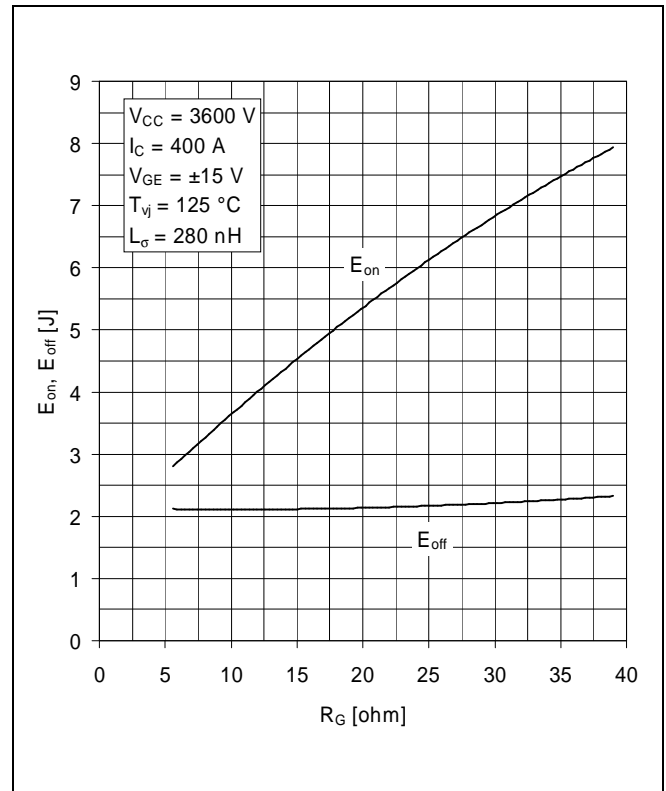

**Fig. 6** Typical switching energies per pulse vs gate resistor

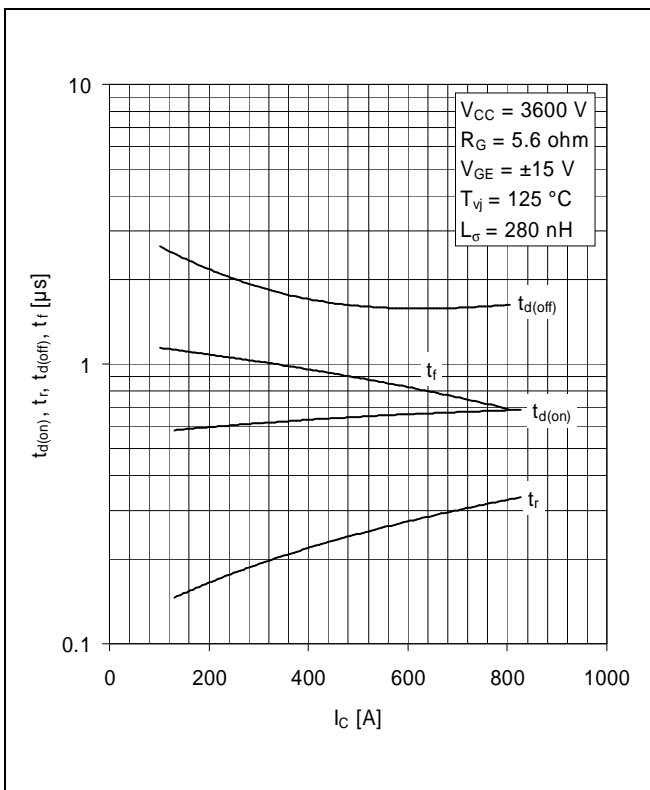

**Fig. 7** Typical switching times vs collector current

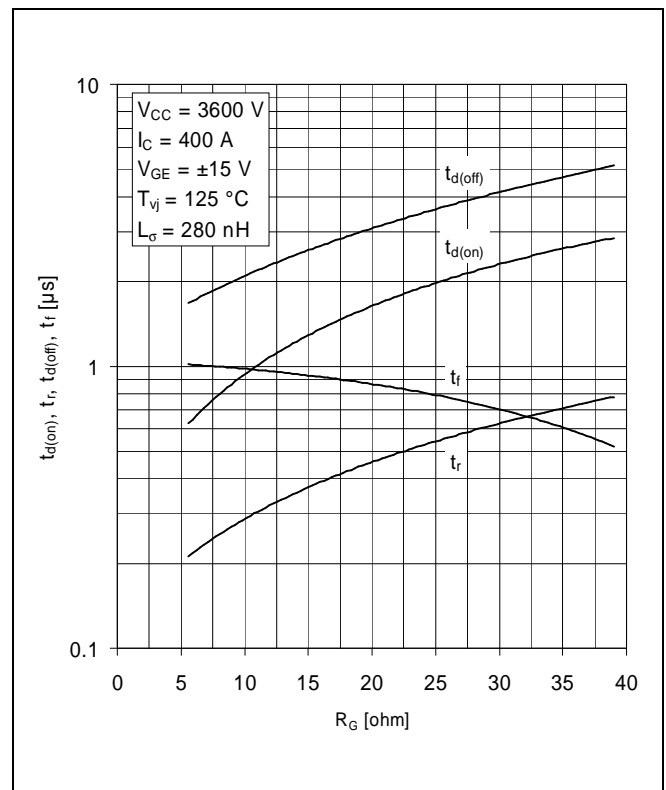

**Fig. 8** Typical switching times vs gate resistor

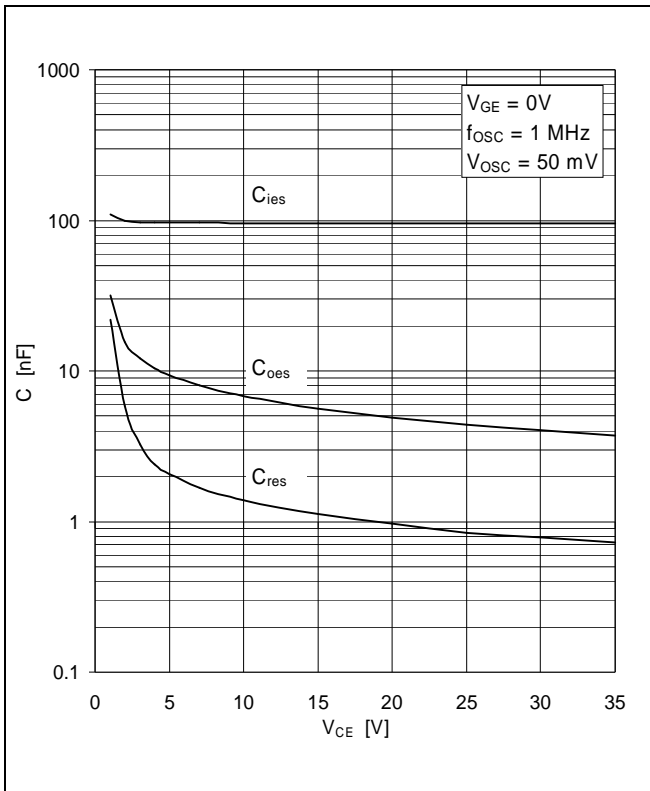

**Fig. 9** Typical capacitances vs collector-emitter voltage

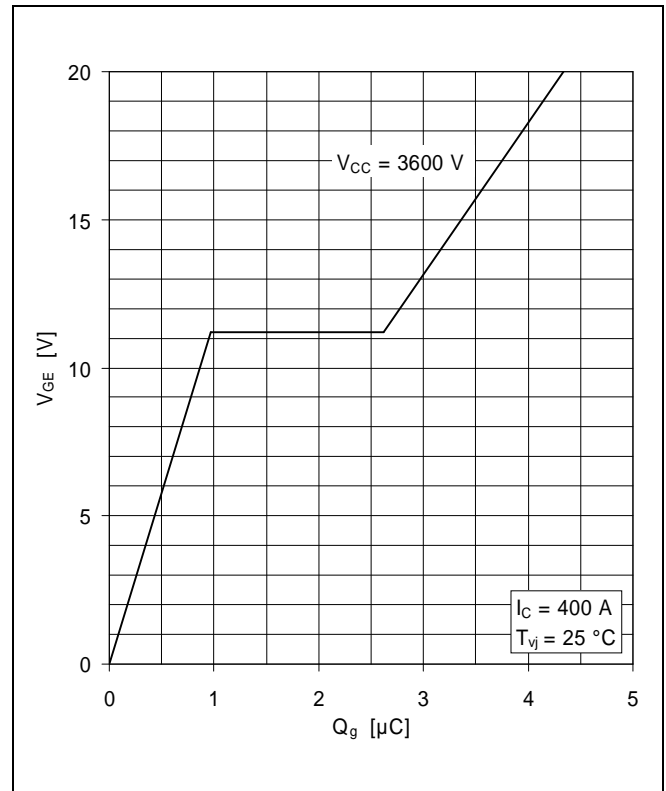

**Fig. 10** Typical gate charge characteristics

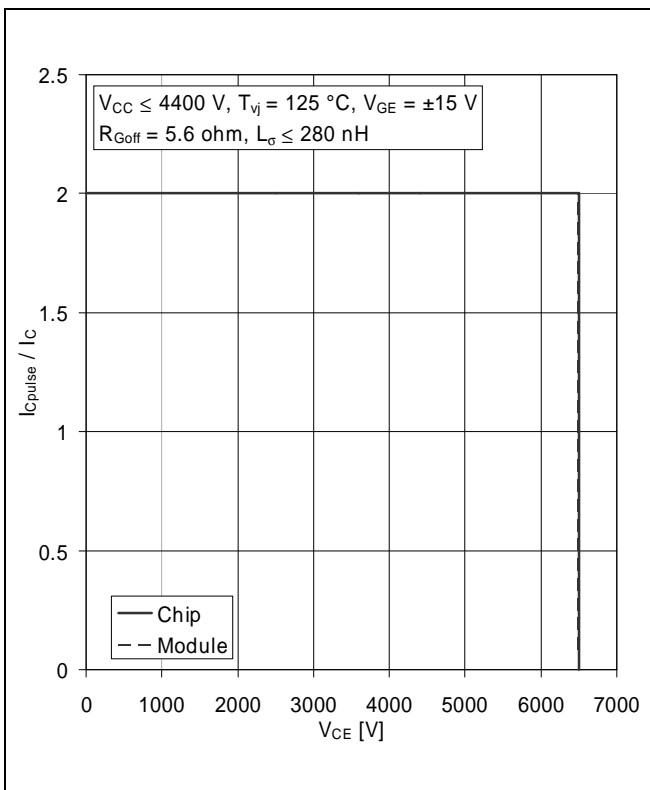

**Fig. 11** Turn-off safe operating area (RBSOA)

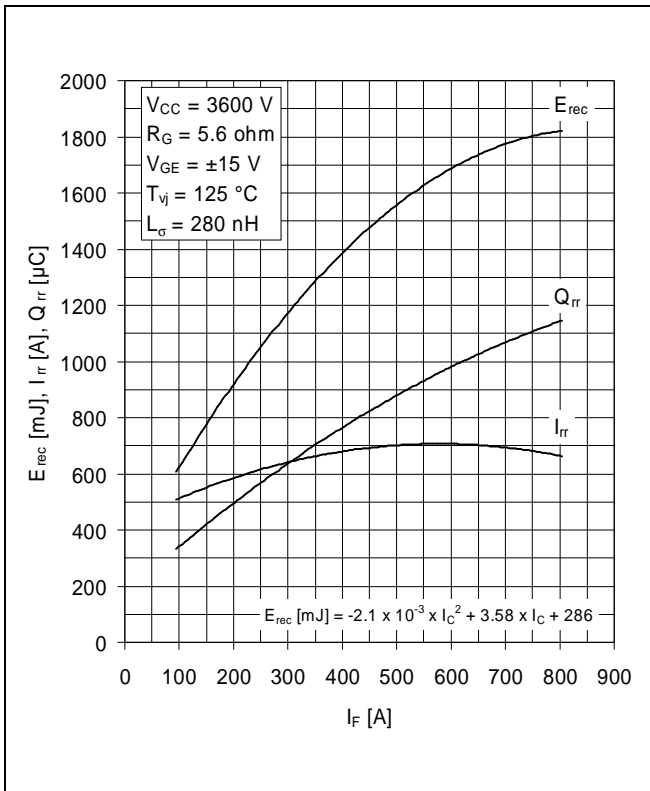

**Fig. 12** Typical reverse recovery characteristics vs forward current

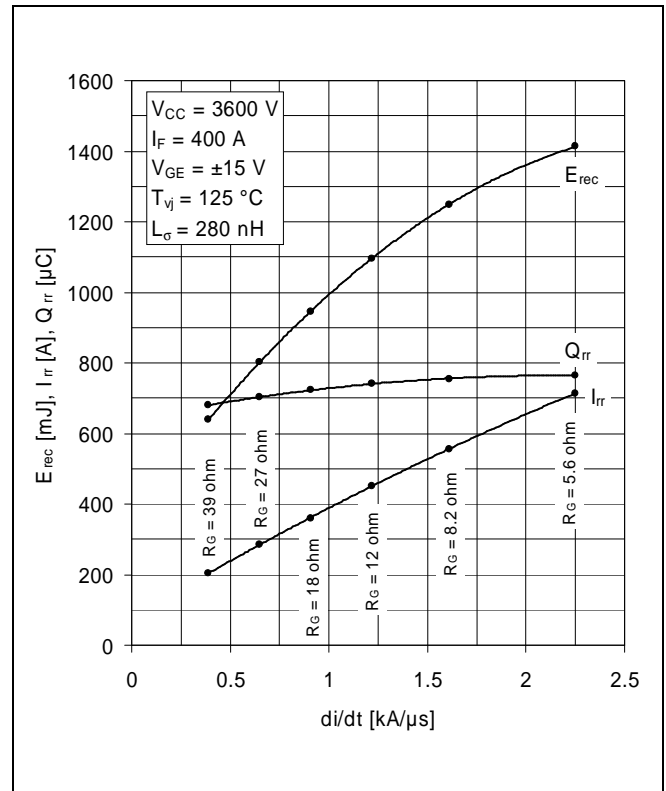

**Fig. 13** Typical reverse recovery characteristics vs di/dt

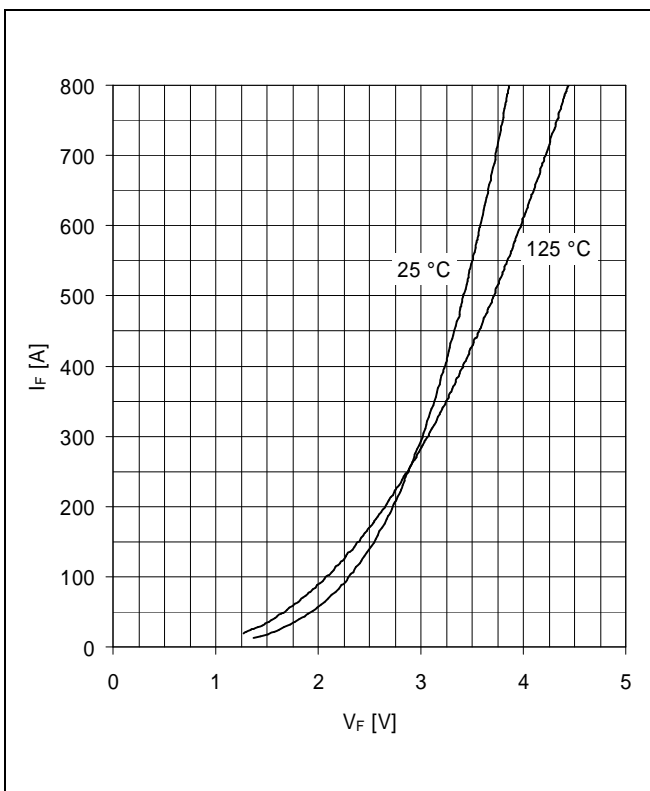

**Fig. 14** Typical diode forward characteristics, chip level

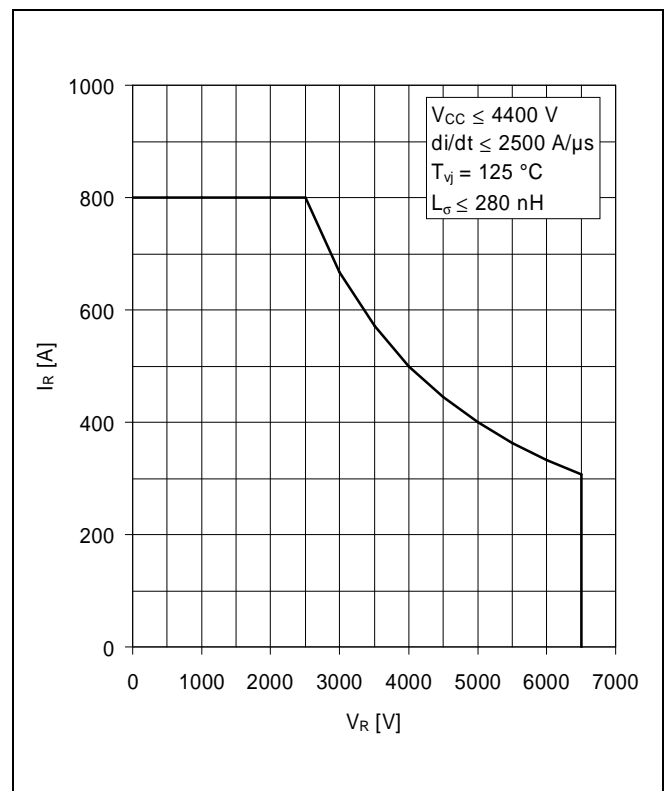

**Fig. 15** Safe operating area diode (SOA)



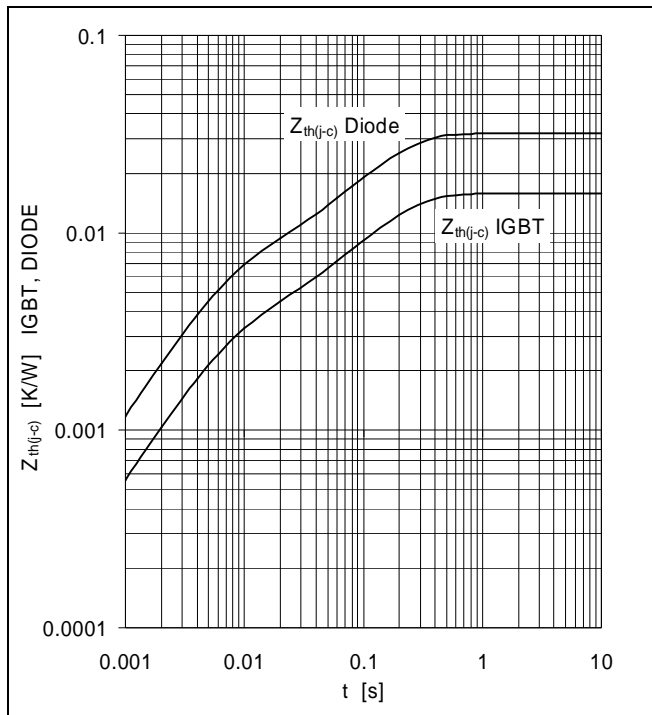

Fig. 16 Thermal impedance vs time

Analytical function for transient thermal impedance:

$$Z_{th(j-c)}(t) = \sum_{i=1}^n R_i (1 - e^{-t/\tau_i})$$

	i	1	2	3	4	5
IGBT	$R_i$ (K/kW)	12.75	2.99			
	$\tau_i$ (ms)	151	5.84			
DIODE	$R_i$ (K/kW)	25.5	6.3			
	$\tau_i$ (ms)	144	5.83			

For detailed information refer to:

- 5SYA 2042-02 Failure rates of HiPak modules due to cosmic rays
- 5SYA 2043-01 Load – cycle capability of HiPaks
- 5SZK 9120-00 Specification of environmental class for HiPak

ABB Switzerland Ltd, Semiconductors reserves the right to change specifications without notice.



**ABB Switzerland Ltd**  
**Semiconductors**  
 Fabrikstrasse 3  
 CH-5600 Lenzburg, Switzerland

Doc. No. 5SYA 1592-01 Jun 07

Telephone +41 (0)58 586 1419  
 Fax +41 (0)58 586 1306  
 Email [abbsem@ch.abb.com](mailto:abbsem@ch.abb.com)  
 Internet [www.abb.com/semiconductors](http://www.abb.com/semiconductors)