

5SED 0890T2240

Rectifier diode module



- Insulated baseplate by AlN ceramic
- Precision pressure contacts for high reliability
- Industry standard housing

Applications

- Uncontrolled line frequency bridge arm
- Input rectifiers in AC/AC converters
- DC power supply

Key parameters

- $V_{RRM} = 2200 \text{ V}$
- $I_{FAV_m} = 889 \text{ A}$
- $I_{FSM} = 22\,000 \text{ A}$
- $V_{TO} = 0.782 \text{ V}$
- $r_T = 0.209 \text{ m}\Omega$

Types

	V_{RRM}
5SED 0890T2240	2 200 V
Conditions	$T_j = -40 \div 160 \text{ }^\circ\text{C}$, half sine waveform, $f = 50 \text{ Hz}$

Mechanical data

M_s	Mounting torque (base - heatsink)	$6 \pm 15 \%$	Nm
M_t	Mounting torque (main terminals)	$12 \pm 15 \%$	Nm
m	Weight	1.4	kg
a	Acceleration resistance	50	m/s^2
UL recognized, file no.		E500543	

Fig. 1 Case

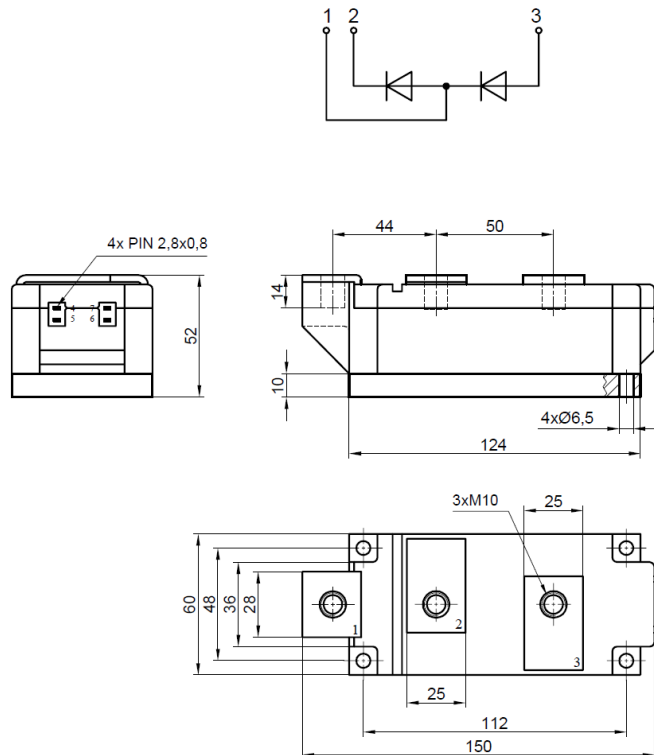

Maximum ratings		Maximum limits	Unit
V_{RRM}	Repetitive peak reverse voltage $T_j = -40 \div 160 \text{ }^\circ\text{C}$	2200	V
I_{FAVm}	Average forward current	$T_c = 85 \text{ }^\circ\text{C}$	889
		$T_c = 100 \text{ }^\circ\text{C}$	754
		$T_c = 110 \text{ }^\circ\text{C}$	656
I_{FRMS}	RMS forward current	$T_c = 85 \text{ }^\circ\text{C}$	1396
		$T_c = 100 \text{ }^\circ\text{C}$	1184
		$T_c = 110 \text{ }^\circ\text{C}$	1031
I_{RRM}	Repetitive reverse current half sine waveform, $f = 50 \text{ Hz}$, peak value	$V_R = V_{RRM}$	30 mA
I_{FSM}	Non repetitive peak surge current $V_R = 0 \text{ V}$, half sine pulse	$t_p = 8.3 \text{ ms}$	23,500
		$t_p = 10 \text{ ms}$	22,000
I^2t	Limiting load integral $V_R = 0 \text{ V}$, half sine pulse	$t_p = 8.3 \text{ ms}$	2,292,000
		$t_p = 10 \text{ ms}$	2,420,000
$T_{jmin} - T_{jmax}$	Operating temperature range	-40 \div 160	$^\circ\text{C}$
T_{STG}	Storage temperature range	-40 \div 125	$^\circ\text{C}$

Unless otherwise specified $T_j = 160 \text{ }^\circ\text{C}$

Insulation characteristics		Value			Unit
		min	typ	max	
V_{ISOL}	Isolation voltage (base – terminals) RMS, sine waveform, $f = 50 \text{ Hz}$, $T_j = 25 \text{ }^\circ\text{C}$, $t = 1 \text{ min}$			3600	V

Forward characteristics		Value			Unit
		min	typ	max	
V_{T0}	Threshold voltage			0.782	V
r_T	Forward slope resistance $I_{F1} = 1398 \text{ A}$, $I_{F2} = 4194 \text{ A}$			0.209	$\text{m}\Omega$
V_{FM}	Maximum forward voltage	$I_{FM} = 1\,000 \text{ A}$		0.980	V
		$I_{FM} = 1\,500 \text{ A}$		1.100	

Unless otherwise specified $T_j = 160 \text{ }^\circ\text{C}$

Reverse recovery characteristics		Value			Unit
		min	typ	max	
Q_{rr}	Recovered charge $I_{FM} = 1000 \text{ A}$, $di_F/dt = 10 \text{ A}/\mu\text{s}$, $V_R = 100 \text{ V}$		1400		μC
I_{rrM}	Reverse recovery maximum current the same conditions as at Q_{rr}		150		
t_{rr}	Reverse recovery time the same conditions as at Q_{rr}		21		

Unless otherwise specified $T_j = 160 \text{ }^\circ\text{C}$

Thermal parameters		Value	Unit
R_{thjc}	Thermal resistance junction to case	per arm	65.0
		per module	32.5
R_{thch}	Thermal resistance case to heatsink	per arm	20.0
		per module	10.0

STATUS	SECURITY LEVEL	DOCUMENT ID	REV.	LANG.	PAGE
Released	Public	5SED 0890T2240, TS – MD/333/15 Nov 20	A	en	2/5

Transient thermal impedance

Analytical function for transient thermal impedance

$$Z_{thjc} = \sum_{i=1}^4 R_i (1 - \exp(-t/\tau_i))$$

Correction for periodic waveforms

Angle	Waveform	Correction Factor	Unit
180°	sine	3.0	K/kW
120°	sine	4.7	K/kW
60°	sine	7.0	K/kW
180°	rectangular	4.8	K/kW
120°	rectangular	7.4	K/kW
60°	rectangular	12.0	K/kW

i	1	2	3	4
τ_i (s)	3.40	0.60	0.10	0.01
R_i (K/kW)	23.00	22.00	13.70	6.3

Fig. 2 Dependence transient thermal impedance junction to case on square pulse

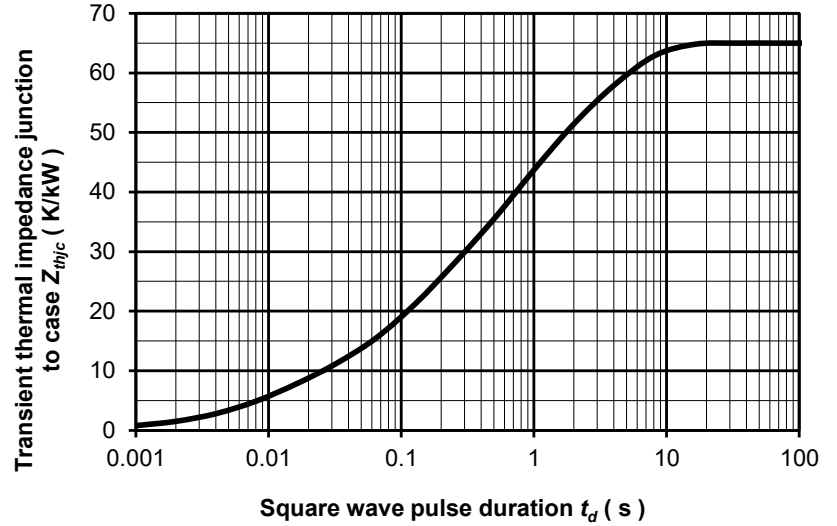

Forward and surge characteristics

Fig. 3 Maximum forward voltage drop characteristics

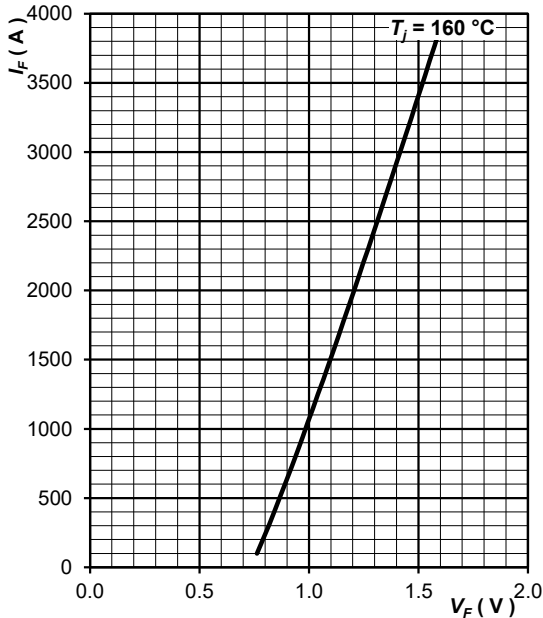
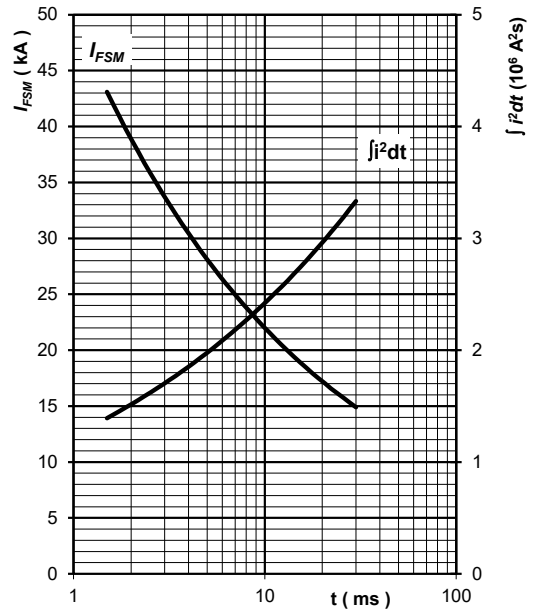

Fig. 4 Surge forward current vs. pulse length, half sine wave, single pulse, $V_R = 0$ V, $T_j = T_{jmax}$



Power loss and maximum case temperature characteristics per arm

Fig. 5 Forward power loss vs. average forward current, sine waveform, $f = 50 \text{ Hz}$, $T = 1/f$

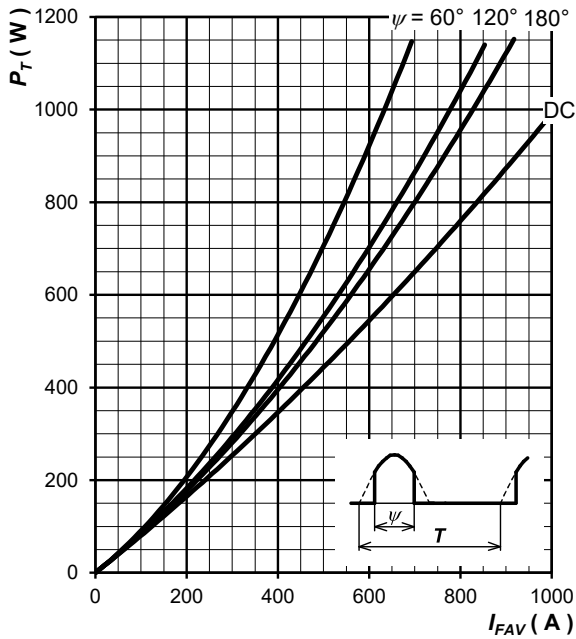

Fig. 6 Forward power loss vs. average forward current, square waveform, $f = 50 \text{ Hz}$, $T = 1/f$

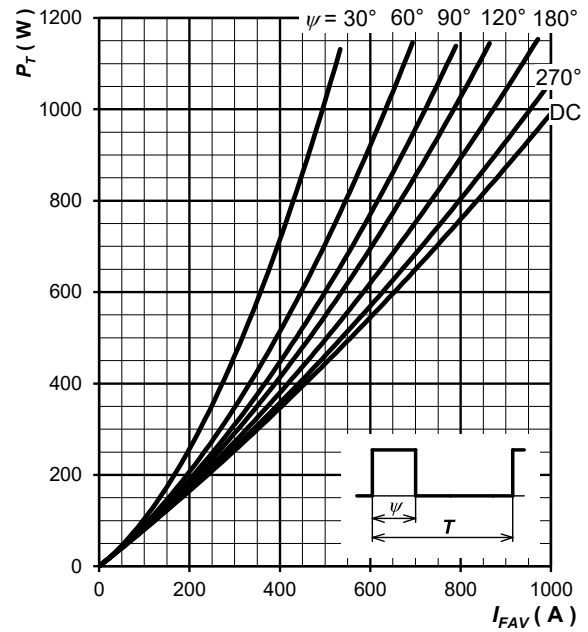

Fig. 7 Max. case temperature vs. aver. forward current, sine waveform, $f = 50 \text{ Hz}$, $T = 1/f$

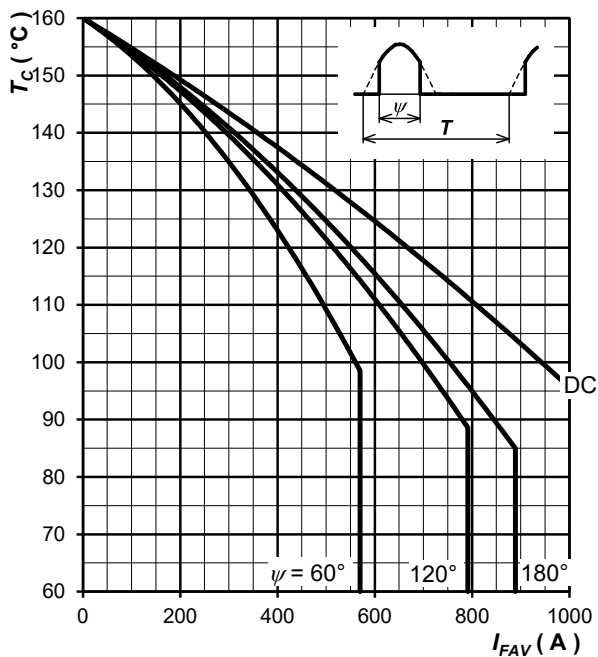
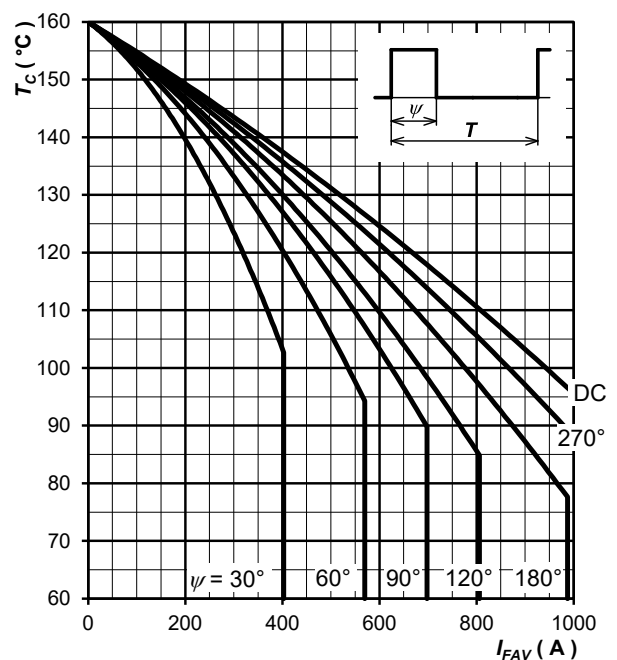

Fig. 8 Max. case temperature vs. aver. forward current, square waveform, $f = 50 \text{ Hz}$, $T = 1/f$



Note: Figures number 5 + 8 have been calculated without considering any forward and reverse recovery losses. They are valid for $f = 50$ or 60 Hz operation.

STATUS	SECURITY LEVEL	DOCUMENT ID	REV.	LANG.	PAGE
Released	Public	5SED 0890T2240, TS – MD/333/15 Nov 20	A	en	4/5

ABB Power Grids Czech Republic s.r.o.

A Hitachi ABB Joint Venture
Semiconductors
Novodvorska 1768/138a
142 21 Praha 4
Czech Republic

hitachiabb-powergrids.com/semiconductors

Note

We reserve all rights in this document and in the information contained therein. Reproduction use or disclosure to third parties without expressed authority is strictly forbidden. © 2020 Hitachi Power Grids. All rights reserved.

STATUS	SECURITY LEVEL	DOCUMENT ID	REV.	LANG.	PAGE
Released	Public	5SED 0890T2240, TS – MD/333/15 Nov 20	A	en	5/5