

Rectifier Diode

5SDD 50N6000

V_{RSM}	=	6000 V
$I_{F(AV)M}$	=	4210 A
$I_{F(RMS)}$	=	6610 A
I_{FSM}	=	$71.2 \cdot 10^3$ A
V_{F0}	=	0.80 V
r_F	=	0.134 m Ω

Doc. No. 5SYA1188-01 Jun. 17

- Patented free-floating silicon technology
- Low on-state and switching losses
- Optimum power handling capability

Blocking

Maximum rated values ¹⁾

Parameter	Symbol	Conditions	Value	Unit
Max repetitive peak reverse voltage	V_{RRM}	$f = 50$ Hz, $t_p = 10$ ms, $T_{vj} = 0 \dots 150$ °C, Note 1	6000	V
Max non-repetitive peak reverse voltage	V_{RSM}	$f = 5$ Hz, $t_p = 10$ ms, $T_{vj} = 0 \dots 150$ °C, Note 1	6000	V

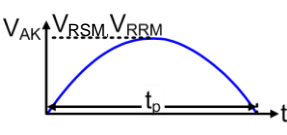

Characteristic values

Parameter	Symbol	Conditions	min	typ	max	Unit
Reverse leakage current	I_{RRM}	V_{RRM} , $T_{vj} = 0 \dots 150$ °C			400	mA

Note 1: Voltage de-rating factor of 0.11% per °C is applicable for T_{vj} below +25 °C.

Mechanical data

Maximum rated values ¹⁾

Parameter	Symbol	Conditions	min	typ	max	Unit
Mounting force	F_M		81	90	108	kN
Acceleration	a	Device unclamped			50	m/s ²
Acceleration	a	Device clamped			100	m/s ²

Characteristic values

Parameter	Symbol	Conditions	min	typ	max	Unit
Weight	m				2.8	kg
Housing thickness	H	$F_M = 90$ kN, $T_a = 25$ °C	34.5		35.2	mm
Surface creepage distance	D_S		56			mm
Air strike distance	D_a		22			mm

1) Maximum rated values indicate limits beyond which damage to the device may occur

ABB Switzerland Ltd, Semiconductors reserves the right to change specifications without notice.



On-state

Maximum rated values ¹⁾

Parameter	Symbol	Conditions	min	typ	max	Unit
Average on-state current	$I_{F(AV)M}$	Half sine wave, $T_c = 90\text{ °C}$			4210	A
RMS on-state current	$I_{F(RMS)}$				6610	A
Peak non-repetitive surge current	I_{FSM}	$t_p = 10\text{ ms}$, $T_{vj} = 150\text{ °C}$, sine half wave, $V_R = 0\text{ V}$, after surge			$71.2 \cdot 10^3$	A
Limiting load integral	I^2t				$25.3 \cdot 10^6$	A ² s

Characteristic values

Parameter	Symbol	Conditions	min	typ	max	Unit
On-state voltage	V_F	$I_F = 5000\text{ A}$, $T_{vj} = 150\text{ °C}$		1.42	1.47	V
Threshold voltage	V_{F0}	$T_{vj} = 150\text{ °C}$ $I_F = 2500 \dots 8000\text{ A}$		0.78	0.80	V
Slope resistance	r_F				0.128	0.134

Switching

Characteristic values

Parameter	Symbol	Conditions	min	typ	max	Unit
Reverse recovery charge	Q_{rr}	$di_F/dt = -10\text{ A}/\mu\text{s}$, $V_R = 200\text{ V}$ $I_F = 4000\text{ A}$, $T_{vj} = 150\text{ °C}$		15000	20000	μAs
Reverse recovery current	I_{RM}				360	450

Thermal

Maximum rated values ¹⁾

Parameter	Symbol	Conditions	min	typ	max	Unit
Operating junction temperature range	T_{vj}		0		150	°C
Storage temperature range	T_{stg}		-40		150	°C

Characteristic values

Parameter	Symbol	Conditions	min	typ	max	Unit
Thermal resistance junction to case	$R_{th(j-c)}$	Double-side cooled $F_m = 81... 108 \text{ kN}$			5.7	K/kW
	$R_{th(j-c)A}$	Anode-side cooled $F_m = 81... 108 \text{ kN}$			11.4	K/kW
	$R_{th(j-c)C}$	Cathode-side cooled $F_m = 81... 108 \text{ kN}$			11.4	K/kW
Thermal resistance case to heatsink	$R_{th(c-h)}$	Double-side cooled $F_m = 81... 108 \text{ kN}$			1	K/kW
	$R_{th(c-h)}$	Single-side cooled $F_m = 81... 108 \text{ kN}$			2	K/kW

Analytical function for transient thermal impedance:

$$Z_{th(j-c)}(t) = \sum_{i=1}^n R_i (1 - e^{-t/\tau_i})$$

i	1	2	3	4
R_i (K/kW)	3.731	1.250	0.434	0.292
τ_i (s)	0.8113	0.1014	0.0089	0.0015

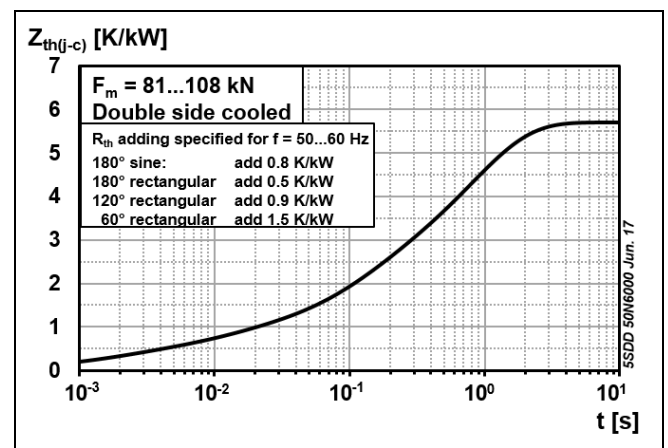

Fig. 1 Transient thermal impedance (junction-to-case) vs. time

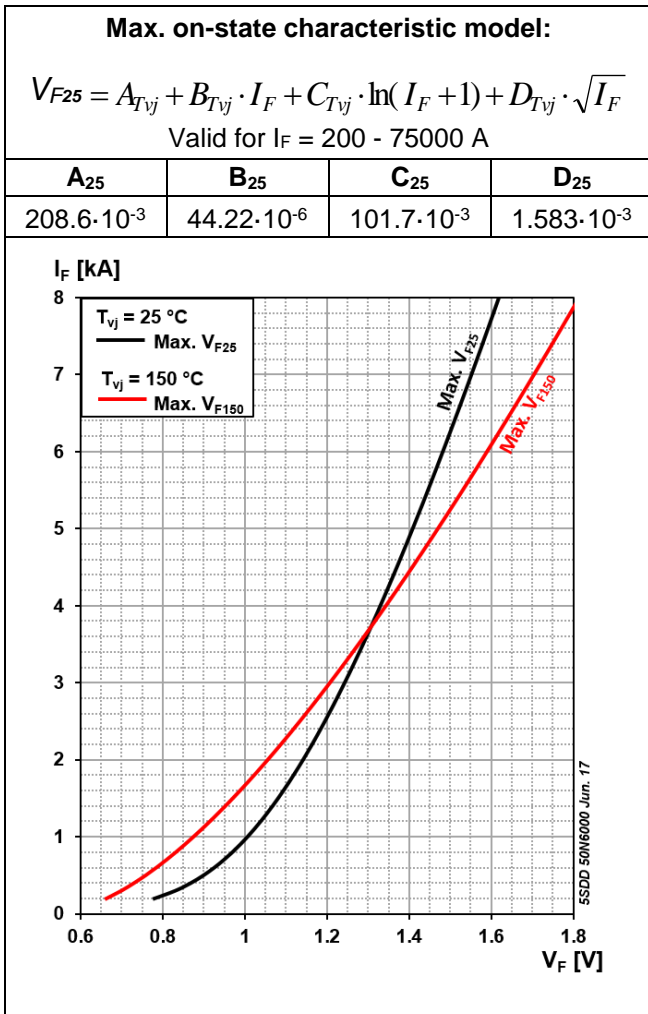

Fig. 2 On-state voltage characteristics

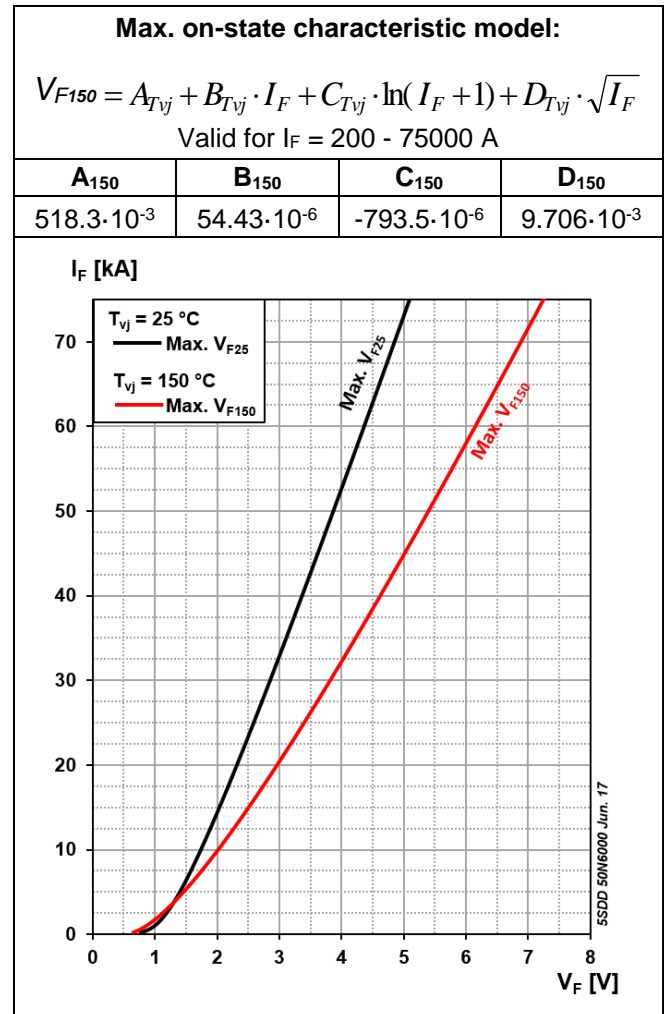

Fig. 3 On-state voltage characteristics

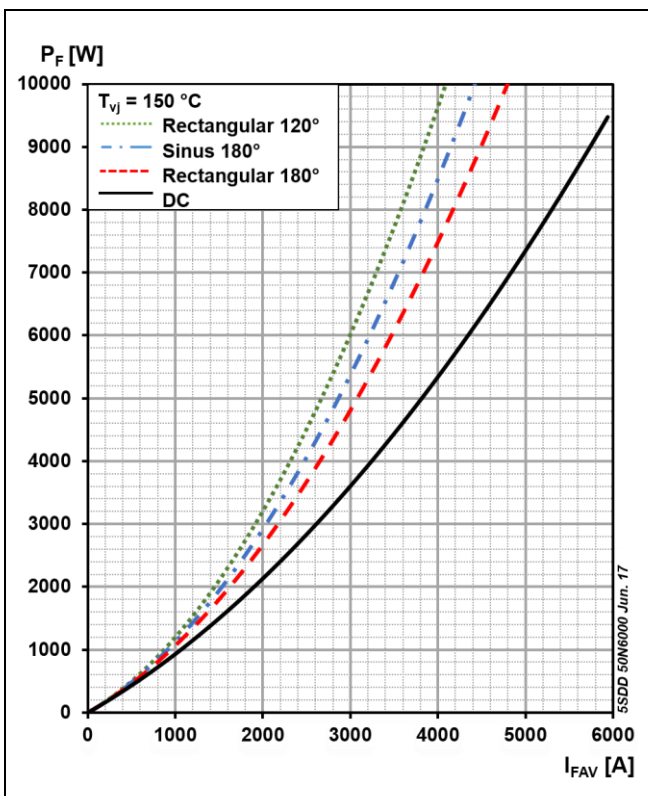

Fig. 4 On-state power dissipation vs. mean on-state current

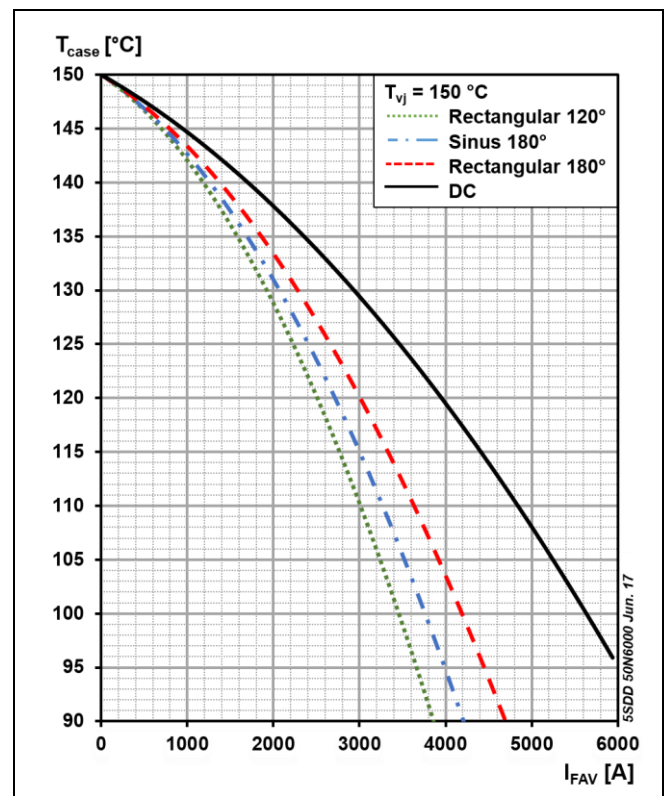

Fig. 5 Max. permissible case temperature vs. mean on-state current

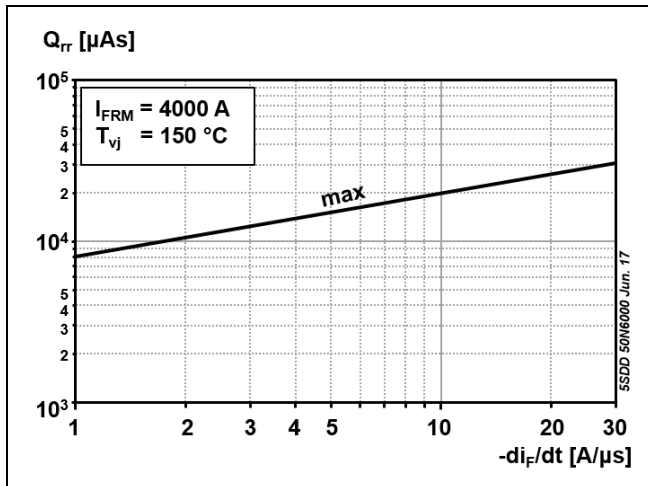

Fig. 6 Reverse recovery charge vs. decay rate of on-state current

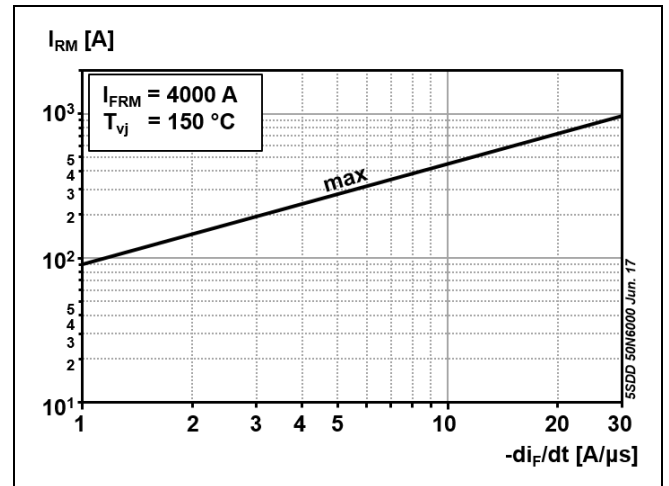

Fig. 7 Peak reverse recovery current vs. decay rate of on-state current

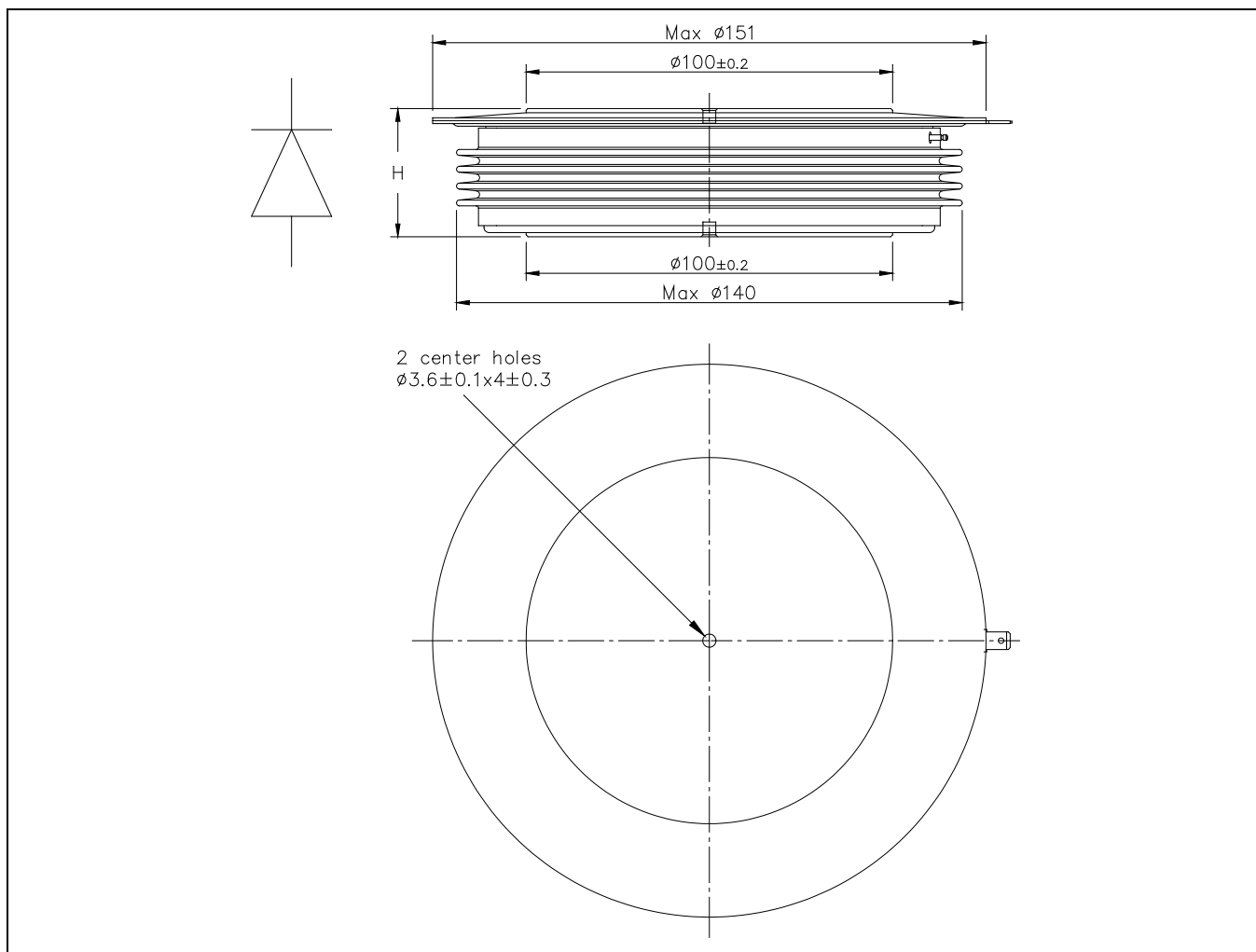

Fig. 8 Device Outline Drawing

Related documents:

5SYA 2020	Design of RC-Snubbers for Phase Control Applications
5SYA 2029	High Power Rectifier Diodes
5SYA 2036	Recommendations regarding mechanical clamping of Press Pack High Power Semiconductors
5SYA 2048	Field Measurements on High Power Press-Pack Semiconductors
5SYA 2051	Voltage Ratings of High Power Semiconductors
5SZK 9104	Specification of environmental class for pressure contact diodes, PCTs and GTO, Storage
5SZK 9105	Specification of environmental class for pressure contact diodes, PCTs and GTO, Transportation
5SZK 9115	Specification of environmental class for presspack Diodes, PCTs and GTOs, Operation (Industry)
5SZK 9116	Specification of environmental class for presspack Diodes, PCTs and GTOs, Operation (Traction)

Please refer to <http://www.abb.com/semiconductors> for current version of documents.

ABB Switzerland Ltd, Semiconductors reserves the right to change specifications without notice.



ABB Switzerland Ltd
Semiconductors
 Fabrikstrasse 3
 CH-5600 Lenzburg, Switzerland

Doc. No. 5SYA1188-01 Jun. 17

Telephone +41 (0)58 586 1419
 Fax +41 (0)58 586 1306
 Email abbsem@ch.abb.com
 Internet www.abb.com/semiconductors